

WERKZEUGAUFNAHMEN  
SPANNZANGEN  
TOOLHOLDERS  
COLLETS



Robert-Bosch-Str. 2  
D-75233 Tiefenbronn  
Telefon: +49 7234 94592-0  
Telefax: +49 7234 94592-29  
E-Mail: [info@stalex.de](mailto:info@stalex.de)

# INHALT

## contents



### WERKZEUGAUFNAHMEN

3-21

toolholders

#### MAS 403 BT Werkzeugaufnahmen

5-8

MAS 403 BT toolholders

#### DIN 69871 Werkzeugaufnahmen

9-12

DIN 69871 toolholders

#### DIN 2080 ISO Werkzeugaufnahmen

13-16

DIN 2080 ISO toolholders

#### HSK und Morse Konus Werkzeugaufnahmen

17-18

HSK and morse taper toolholders

#### ER-Werkzeugaufnahmen mit Zylinderschaft

19-21

straight shank ER collet holders



### SPANNZANGEN

22-44

collets

#### ER Standard Spannzangen

22-32

ER standard collets

#### ERC Spannzangen abgedichtet

34-37

ERC coolant sealed collets

#### ERT Spannzangen mit Vierkantmitnahme

38-40

ERT tapping collets

#### ER-Spannzangen - Zollabmessungen

41-43

inch sized ER collets

#### ORTLIEB-Spannzangen OZ 25 DIN 6388

44

ORTLIEB collets OZ 25 DIN 6388



### ZUBEHÖR FÜR WERKZEUGAUFNAHMEN

45-50

accessories for toolholders

#### Überwurfmuttern und Zangenschlüssel

46-47

locknuts and spanners

#### Anzugsbolzen

48

pull studs

#### Gestell für Werkzeugaufnahmen & Holzsteckleiste für ER-Spannzangen

49

tool clamping stand & wooden collet stands

#### Ersatzschrauben für Werkzeugaufnahmen

49

spare toolholder screws

#### Standard Druckspannzangen

50

workholding collets



**WERKZEUGAUFNAHMEN**

toolholders

## KONISCHE WERKZEUGAUFNAHMEN - STANDARD

toolholders taper standards



### MAS 403 BT

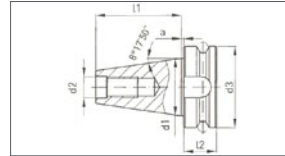

KONUS	a +/-0.2	d1	d2	d3 -0.1	l2	l1 +/-0.02
BT30	2	31.75	M12	46	20	48.4
BT40	2	44.45	M16	63	25	65.4
BT50	3	69.85	M24	100	35	101.8

### DIN 69871

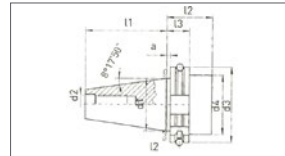

KONUS	a +/-0.2	d1	d2	d3 -0.1	d4 max.	l2 min.	l3 -0.1	l1 -0.3
DIN 30	3.2	31.75	M12	50.0	44	35	19.1	47.8
DIN 40	3.2	44.45	M16	63.55	50	35	19.1	69.4
DIN 50	3.2	69.85	M24	97.5	80	35	19.1	101.75

### DIN 2080 (ISO)

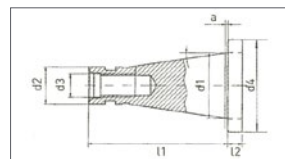

KONUS	a +/-0.2	d1	d2 a10	d3	d4	l2 +/-0.15	l1
ISO 30	1.6	31.75	17.4	M12	50	8	68.4
ISO 40	1.6	44.45	25.3	M16	63	10	93.4
ISO 50	3.2	69.85	39.6	M24	97.5	12	126.8

Die Konen sind AT3-konform.  
Die Rundlaufgenauigkeit beträgt  
max. 5µ.

Tapers are according to AT3  
specifications.  
The run-out accuracy between  
outside taper to the taper of  
collet cavity is max. 5µ.

### HSK (DIN 69893 A)

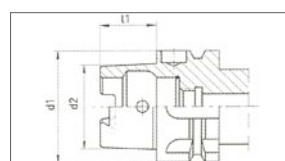

KONUS	d1	d2	l1
HSK 50	50	38	25
HSK 63	63	48	32
HSK 80	80	60	40



**MAS 403 BT  
WERKZEUGAUFNAHMEN**

MAS 403 BT  
toolholders

## WERKZEUGAUFNAHMEN FÜR ER ZANGEN

ER collet chucks

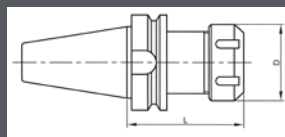

### MAS 403 BT

Bestell-Nr. BT30 order no. BT30	L	D	Spannzangentyp collet type	Ø Spannbereich Ø clamping range	Euro
BT30 ER16	60	28	ER16	Ø 1-10 mm	60,00
BT30 ER25	60	42	ER25	Ø 2-16 mm	60,00
BT30 ER32	60	50	ER32	Ø 3-20 mm	64,00

Bestell-Nr. BT40 order no. BT40	L	D	Spannzangentyp collet type	Ø Spannbereich Ø clamping range	Euro
BT40 ER16	60	32	ER16	Ø 1-10 mm	50,00
BT40 ER16 100	100	32	ER16	Ø 1-10 mm	62,00
BT40 ER16 130M	130	22	ER16	Ø 1-10 mm	76,00
BT40 ER20	70	35	ER20	Ø 2-13 mm	50,00
BT40 ER20 100	100	35	ER20	Ø 2-13 mm	62,00
BT40 ER25	70	42	ER25	Ø 2-16 mm	50,00
BT40 ER25 100	100	42	ER25	Ø 2-16 mm	62,00
BT40 ER32	70	50	ER32	Ø 3-20 mm	50,00
BT40 ER32 100	100	50	ER32	Ø 3-20 mm	62,00
BT40 ER40	70	63	ER40	Ø 4-26 mm	53,00
BT40 ER40 100	100	63	ER40	Ø 4-26 mm	64,00

Bestell-Nr. BT50 order no. BT50	L	D	Spannzangentyp collet type	Ø Spannbereich Ø clamping range	Euro
BT50 ER25	70	42	ER25	Ø 2-16 mm	100,00
BT50 ER32	70	50	ER32	Ø 3-20 mm	100,00
BT50 ER40	80	63	ER40	Ø 4-26 mm	104,00
BT50 ER40 150	150	63	ER40	Ø 4-26 mm	156,00
BT50 ER50	100	78	ER50	Ø 12-34 mm	156,00

## FRÄSERAUFNAHMEN

face mill adaptors

### MAS 403 BT



Bestell-Nr. BT30 order no. BT30	D	D1	L	Euro
BT30 FM16	16	40	40	60,00
BT30 FM22	22	48	40	60,00

Bestell-Nr. BT40 order no. BT40	D	D1	L	Euro
BT40 FM16	16	40	40	54,00
BT40 FM22	22	48	45	54,00
BT40 FM27	27	60	45	56,00
BT40 FM32	32	78	50	58,00
BT40 FM40	40	89	55	60,00

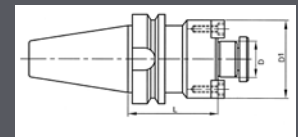

Bestell-Nr. BT50 order no. BT50	D	D1	L	Euro
BT50 FM16	16	40	55	100,00
BT50 FM22	22	48	55	100,00
BT50 FM27	27	60	55	104,00
BT50 FM32	32	78	55	104,00
BT50 FM40	40	89	55	108,00

## WELDON-AUFNAHMEN

WELDON adaptors



Bestell-Nr. BT40 order no. BT40	D1	D	L	Euro
BT40 W06	6	25	50	50,00
BT40 W08	8	28	50	60,00
BT40 W10	10	35	63	50,00
BT40 W12	12	42	63	50,00
BT40 W14	14	44	50	60,00
BT40 W16	16	48	63	50,00
BT40 W20	20	52	63	50,00
BT40 W25	25	65	90	54,00
BT40 W32	32	72	100	64,00
BT40 W40	40	80	120	76,00

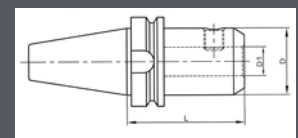

Bestell-Nr. BT50 order no. BT50	D1	D	L	Euro
BT50 W10	10	35	63	96,00
BT50 W12	12	42	80	96,00
BT50 W16	16	48	80	96,00
BT50 W20	20	52	80	96,00
BT50 W25	25	65	100	100,00
BT50 W32	32	72	105	104,00
BT50 W40	40	80	120	116,00

## MORSEKONUSAUFNAHMEN

morse taper adaptors

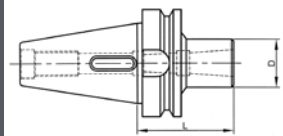

### MAS 403 BT

Bestell-Nr. BT40 order no. BT40	MT	D	L	Euro
BT40 MT1	1	25	50	52,00
BT40 MT2	2	32	50	52,00
BT40 MT3	3	40	70	56,00
BT40 MT4	4	48	95	60,00

Bestell-Nr. BT50 order no. BT50	MT	D	L	Euro
BT50 MT2	2	32	60	98,00
BT50 MT3	3	40	65	100,00
BT50 MT4	4	48	95	104,00
BT50 MT5	5	63	105	110,00

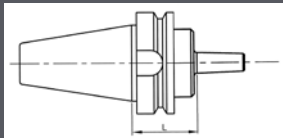

## BOHRFUTTERAUFNAHMEN

drill chuck adaptors

Bestell-Nr. BT40 order no. BT40	D	L	Euro
BT40 B12	B12	25	50,00
BT40 B16	B16	25	50,00
BT40 B18	B18	25	50,00





**DIN 69871  
WERKZEUGAUFNAHMEN**

DIN 69871  
toolholders

## ER-SPANNZANGENAUFNAHMEN

ER collet chucks

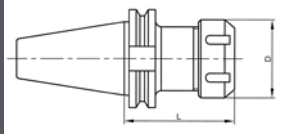

### DIN 69871

Bestell-Nr. DIN30 order no. DIN30	L	D	Spannzangentyp collet type	Ø Spannbereich Ø clamping range	Euro
DIN30 ER16	60	28	ER16	Ø 1-10 mm	60,00
DIN30 ER25	60	42	ER25	Ø 2-16 mm	60,00
DIN30 ER32	60	50	ER32	Ø 3-20 mm	64,00

Bestell-Nr. DIN40 order no. DIN40	L	D	Spannzangentyp collet type	Ø Spannbereich Ø clamping range	Euro
DIN40 ER16	60	28	ER16	Ø 1-10 mm	50,00
DIN40 ER16 100	100	28	ER16	Ø 1-10 mm	62,00
DIN40 ER16 130M	130	22	ER16	Ø 1-10 mm	76,00
DIN40 ER20	70	34	ER20	Ø 2-13 mm	50,00
DIN40 ER20 100	100	34	ER20	Ø 2-13 mm	62,00
DIN40 ER25	70	42	ER25	Ø 2-16 mm	50,00
DIN40 ER25 100	100	42	ER25	Ø 2-16 mm	62,00
DIN40 ER32	70	50	ER32	Ø 3-20 mm	50,00
DIN40 ER32 100	100	50	ER32	Ø 3-20 mm	62,00
DIN40 ER40	70	63	ER40	Ø 4-26 mm	53,00
DIN40 ER40 100	100	63	ER40	Ø 4-26 mm	64,00

Bestell-Nr. DIN50 order no. DIN50	L	D	Spannzangentyp collet type	Ø Spannbereich Ø clamping range	Euro
DIN50 ER32	70	50	ER32	Ø3-20 mm	100,00
DIN50 ER40	80	63	ER40	Ø4-26 mm	104,00
DIN50 ER40 150	150	63	ER40	Ø4-26 mm	156,00
DIN50 ER50	100	78	ER50	Ø12-34 mm	156,00

## FRÄSERAUFNAHMEN

face mill adaptors

### DIN 69871

Bestell-Nr. DIN30 order no. DIN30	D	D1	L	Euro
DIN30 FM16	16	40	35	60,00
DIN30 FM22	22	50	40	60,00

Bestell-Nr. DIN40 order no. DIN40	D	D1	L	Euro
DIN40 FM16	16	40	35	54,00
DIN40 FM22	22	50	35	54,00
DIN40 FM27	27	60	40	56,00
DIN40 FM32	32	78	50	58,00
DIN40 FM40	40	89	50	60,00

Bestell-Nr. DIN50 order no. DIN50	D	D1	L	Euro
DIN50 FM16	16	40	35	100,00
DIN50 FM22	22	50	35	100,00
DIN50 FM27	27	60	40	104,00
DIN50 FM32	32	78	50	104,00
DIN50 FM40	40	89	50	108,00

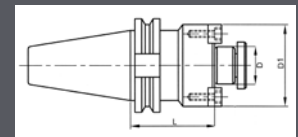

## WELDON-AUFNAHMEN

WELDON adaptors

Bestell-Nr. DIN40 order no. DIN40	D1	D	L	Euro
DIN40 W06	6	25	50	50,00
DIN40 W08	8	28	50	60,00
DIN40 W10	10	35	50	50,00
DIN40 W12	12	42	50	50,00
DIN40 W14	14	44	50	60,00
DIN40 W16	16	48	63	50,00
DIN40 W20	20	52	63	50,00
DIN40 W25	25	65	100	54,00
DIN40 W32	32	72	100	64,00
DIN40 W40	40	80	120	76,00

Bestell-Nr. DIN50 order no. DIN50	D1	D	L	Euro
DIN50 W10	10	35	63	96,00
DIN50 W12	12	42	63	96,00
DIN50 W16	16	48	63	96,00
DIN50 W20	20	52	63	96,00
DIN50 W25	25	65	80	100,00
DIN50 W32	32	72	100	104,00
DIN50 W40	40	80	120	116,00

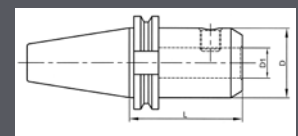

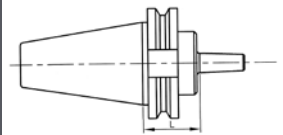
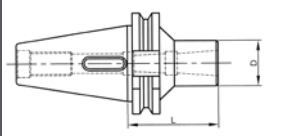

## MORSEKONUSAUFNAHMEN

morse taper adaptors

### DIN 69871

Bestell-Nr. DIN40 order no. DIN40	MT	D	L	Euro
DIN40 MT1	1	25	50	52,00
DIN40 MT2	2	32	50	52,00
DIN40 MT3	3	40	70	56,00
DIN40 MT4	4	48	95	60,00

Bestell-Nr. DIN50 order no. DIN50	MT	D	L	Euro
DIN50 MT2	2	32	60	98,00
DIN50 MT3	3	40	65	100,00
DIN50 MT4	4	48	95	104,00
DIN50 MT5	5	63	105	110,00

## BOHRFUTTERAUFNAHMEN

drill chuck adaptors

Bestell-Nr. DIN40 order no. DIN40	D	L	Euro
DIN40 B12	B12	25	50,00
DIN40 B16	B16	25	50,00
DIN40 B18	B18	25	50,00



**DIN 2080 ISO  
WERKZEUGAUFNAHMEN**

DIN 2080 ISO  
toolholders

## ER-SPANNZANGENAUFNAHMEN

ER collet chucks

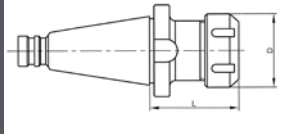

### DIN 2080 ISO

Bestell-Nr. ISO30 order no. ISO30	L	D	Spannzangentyp collet type	Ø Spannbereich Ø clamping range	Euro
ISO30 ER16	50	28	ER16	Ø 1-10 mm	60,00
ISO30 ER25	50	42	ER25	Ø 2-16 mm	60,00
ISO30 ER32	50	50	ER32	Ø 3-20 mm	64,00

Bestell-Nr. ISO40 order no. ISO40	L	D	Spannzangentyp collet type	Ø Spannbereich Ø clamping range	Euro
ISO40 ER25	50	42	ER25	Ø 2-16 mm	50,00
ISO40 ER32	60	50	ER32	Ø 3-20 mm	50,00
ISO40 ER40	60	63	ER40	Ø 4-26 mm	53,00

Bestell-Nr. ISO50 order no. ISO50	L	D	Spannzangentyp collet type	Ø Spannbereich Ø clamping range	Euro
ISO50 ER32	70	50	ER32	Ø 3-20 mm	100,00
ISO50 ER40	70	63	ER40	Ø 4-26 mm	104,00
ISO50 ER50	90	78	ER50	Ø 12-34 mm	156,00

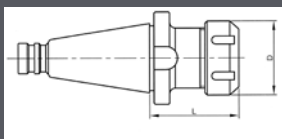

### ISO40 DIN6388-25 SPANNZANGENAUFNAHMEN

ISO40 DIN6388-25 collet chucks

Bestell-Nr. ISO40 order no. ISO40	L	D	Spannzangentyp collet type	Ø Spannbereich Ø clamping range	Euro
ISO40 OZ25	70	60	OZ25	Ø 2-25 mm	56,00

## FRÄSERAUFNAHMEN

face mill adaptors

### DIN 2080 ISO

Bestell-Nr. ISO30 order no. ISO30	D	D1	L	Euro
ISO30 FM16	16	40	30	60,00
ISO30 FM22	22	50	30	60,00

Bestell-Nr. ISO40 order no. ISO40	D	D1	L	Euro
ISO40 FM16	16	40	30	54,00
ISO40 FM22	22	50	30	54,00
ISO40 FM27	27	60	30	56,00
ISO40 FM32	32	78	30	58,00
ISO40 FM40	40	89	30	60,00

Bestell-Nr. ISO50 order no. ISO50	D	D1	L	Euro
ISO50 FM16	16	40	30	100,00
ISO50 FM22	22	50	35	100,00
ISO50 FM27	27	60	35	104,00
ISO50 FM32	32	78	35	104,00
ISO50 FM40	40	89	40	108,00

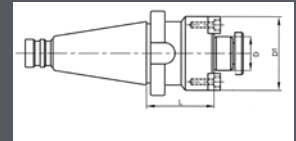

## WELDON-AUFNAHMEN

WELDON adaptors

Bestell-Nr. ISO40 order no. ISO40	D1	D	L	Euro
ISO40 W12	12	42	50	50,00
ISO40 W16	16	48	63	50,00
ISO40 W20	20	52	63	50,00
ISO40 W25	25	65	80	54,00
ISO40 W32	32	72	80	64,00
ISO40 W40	40	80	90	76,00

Bestell-Nr. ISO50 order no. ISO50	D1	D	L	Euro
ISO50 W16	16	48	63	96,00
ISO50 W20	20	52	63	96,00
ISO50 W25	25	65	80	100,00
ISO50 W32	32	72	80	104,00
ISO50 W40	40	90	90	116,00

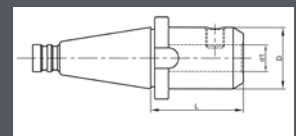

## MORSEKONUSAUFNAHMEN

morse taper adaptors

### DIN 2080 ISO

Bestell-Nr. ISO40 order no. ISO40	MT	D	L	Euro
ISO40 MT1	1	25	50	52,00
ISO40 MT2	2	32	50	52,00
ISO40 MT3	3	40	65	56,00
ISO40 MT4	4	48	95	60,00

Bestell-Nr. ISO50 order no. ISO50	MT	D	L	Euro
ISO50 MT2	2	32	60	98,00
ISO50 MT3	3	40	65	100,00
ISO50 MT4	4	48	70	104,00
ISO50 MT5	5	63	105	110,00

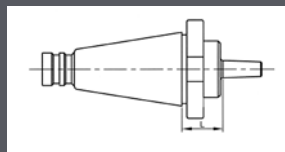
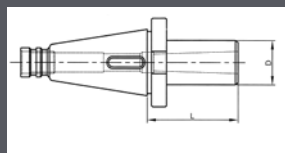

## BOHRFUTTERAUFNAHMEN

drill chuck adaptors

Bestell-Nr. ISO40 order no. ISO40	D	L	Euro
ISO40 B16	B16	18	50,00
ISO40 B18	B18	18	50,00





## **HSK WERKZEUGAUFNAHMEN**

HSK toolholders

## **MORSEKONUS- WERKZEUGAUFNAHMEN**

morse taper toolholders

## HSK A 63 SPANNZANGENAUFNAHMEN

HSK collet holders

### DIN 69893

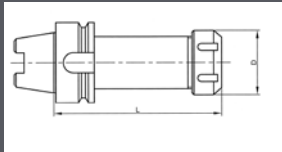

Bestell-Nr. order no.	L	D	Spannzangentyp collet type	Ø Spannbereich Ø clamping range	Euro
HSK63 ER16	100	28	ER16	Ø 1-10 mm	160,00
HSK63 ER25	100	42	ER25	Ø 2-16 mm	160,00
HSK63 ER32	100	50	ER32	Ø 3-20 mm	160,00
HSK63 ER40	100	63	ER40	Ø 4-26 mm	160,00

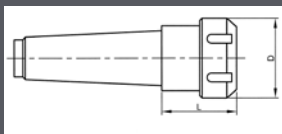

## DIN 228 ER-SPANNZANGENAUFNAHMEN MIT MORSEKEGELSCHAFT

DIN 228 morse taper shank ER collet chucks

Bestell-Nr. MT order no. MT	L	D	Spannzangentyp collet type	Ø Spannbereich Ø clamping range	Euro
MT2 ER25	50	42	ER25 Ø 2-16 mm	32.00	64,00
MT3 ER32	60	50	ER32 Ø 3-20 mm	32.00	64,00
MT4 ER40	80	63	ER40 Ø 4-26 mm	34.00	68,00



**ER-SPANNZANGENAUFNAHMEN  
MIT GERADEM SCHAFT**

straight shank ER collet holders

## ER-SPANNZANGENAUFNAHMEN MIT GERADEM SCHAFT

straight shank ER collet holders



**M= mit ER-Mini-Mutter**  
M= with ER mini locknut



**H= mit ER-Sechskant-Mutter**  
H= with ER hexagon locknut

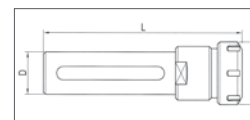

**S= mit ER-Standard-Mutter**  
S= with ER standard locknut



Bestell-Nr.* order no.*	D	D1	L	Spannzangentyp collet type	Ø Spannereich Ø clamping range	Euro
ER0808085M	8	12	85	ER8	Ø 1-5 mm	46,00
ER0810095M	10	12	95	ER8	Ø 1-5 mm	46,00
ER0812095M	12	12	95	ER8	Ø 1-5 mm	46,00



ER1112100M	12	16	100	ER11	Ø 1-7 mm	44,00
ER1116115M	16	16	115	ER11	Ø 1-7 mm	44,00
ER1116115H	16	19	115	ER11	Ø 1-7 mm	44,00
ER1116165M	16	16	165	ER11	Ø 1-7 mm	64,00

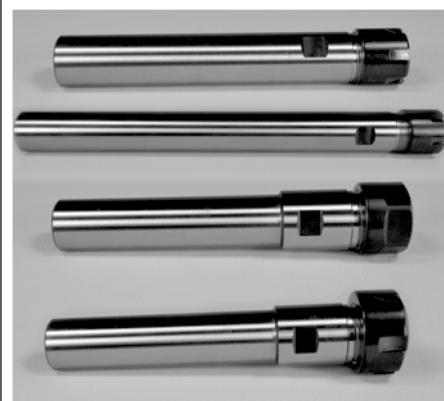

ER1620130M	20	22	130	ER16	Ø 1-10 mm	44,00
ER1620130H	20	28	130	ER16	Ø 1-10 mm	44,00
ER1620130S	20	32	130	ER16	Ø 1-10 mm	44,00
ER1620200M	20	22	200	ER16	Ø 1-10 mm	66,00



ER2020140M	20	28	140	ER20	Ø 2-13 mm	46,00
ER2020140H	20	34	140	ER20	Ø 2-13 mm	46,00
ER2020140S	20	35	140	ER20	Ø 2-13 mm	46,00
ER2025110H	25	34	110	ER20	Ø 2-13 mm	46,00
ER2025110S	25	35	110	ER20	Ø 2-13 mm	46,00
ER2025200M	25	28	200	ER20	Ø 2-13 mm	68,00

\*Endbuchstaben an der Bestell-Nr. kennzeichnen den Typ der Mutter.

\*Last letter on order no. indicates type of clamping nut.

## ER-SPANNZANGENAUFNAHMEN MIT GERADEM SCHAFT

straight shank ER collet holders

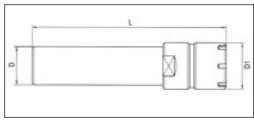

**M= mit ER-Mini-Mutter**  
M= with ER mini locknut

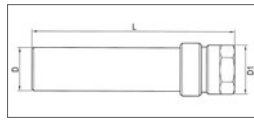

**H= mit ER-Sechskant-Mutter**  
H= with ER hexagon locknut

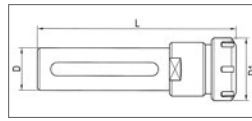

**S= mit ER-Standard-Mutter**  
S= with ER standard locknut

Bestell-Nr.* order no.*	D	D1	L	Spannzangentyp collet type	Ø Spannereich Ø clamping range	Euro
ER2520145M	20	35	145	ER25	Ø 2-16 mm	48,00
ER2525145M	25	35	145	ER25	Ø 2-16 mm	48,00
ER2525200M	25	35	200	ER25	Ø 2-16 mm	68,00
ER25254200M	25.4 (1")	35	200	ER25	Ø 2-16 mm	68,00
ER2532105S	32	42	105	ER25	Ø 2-16 mm	48,00



ER3225110S	25	50	110	ER32	Ø 3-20 mm	50,00
ER3232110S	32	50	110	ER32	Ø 3-20 mm	50,00
ER3240110S	40	50	110	ER32	Ø 3-20 mm	52,00



ER4032140S	32	63	140	ER40	Ø 4-26 mm	64,00
ER4040140S	40	63	140	ER40	Ø 4-26 mm	64,00

\*Endbuchstaben an der Bestell-Nr. kennzeichnen den Typ der Mutter.

\*Last letter on order no. indicates type of clamping nut.



## SPANNZANGEN-PRÄZISIONSSTANDARDS

collet precision standards



### 3 VERSCHIEDENE PRÄZISIONSSTUFEN

3 different precision levels

KLASSE 2	<p><b>Präzise und ökonomisch, DIN 6499-konform, Klasse 2</b>  <b>max. Rundlaufgenauigkeit 15-20 µ.</b></p> <p>Precise and economic, according to DIN6499 class 2          max. 15-20 micron run-out accuracy.</p>
KLASSE 1	<p><b>Höheres Präzisionslevel, DIN 6499-konform, Klasse 1</b>  <b>max. Rundlaufgenauigkeit 10 µ.</b></p> <p>Upper precision level according to DIN 6499 class 1          max. 10 micron run-out accuracy.</p>
TOPAC	<p><b>Höchstes Präzisionslevel mit garantierter Rundlaufgenauigkeit von 5 µ.</b>  <b>Geeignet für hochpräzise und Hochgeschwindigkeitsanwendungen.</b></p> <p>TOP level accuracy with guaranteed run-out accuracy of 5 micron,          suitable for very high precision, tight tolerance and high speed applications.</p>

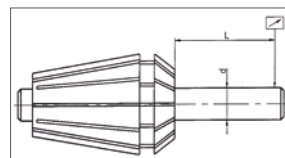

Ø d	L	DIN 6499 Klasse 2	DIN 6499 Klasse 1	STALEX <sup>®</sup> TOPAC
1-1.6	6	0.015	0.010	0.005
1.6-3	10	0.015	0.010	0.005
3-7	16	0.015	0.010	0.005
7-10	25	0.015	0.010	0.005
10-18	40	0.020	0.010	0.005
18-25	50	0.020	0.010	0.005
25-34	60	0.020	0.015	0.010



### MONTAGEANLEITUNG

collet mounting instruction

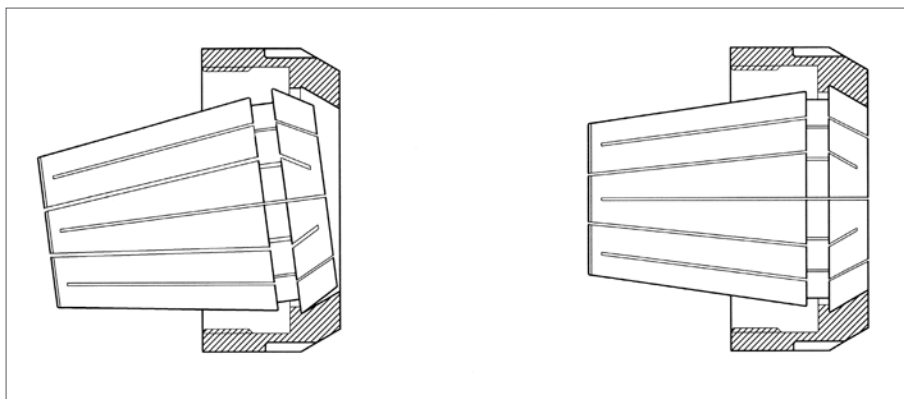



**SPANNZANGEN**

collets

## SPANNZANGEN

collets



### Alle **STALEX** Spannzangen

- sind garantiert in der angegebenen Rundlaufgenauigkeit der jeweiligen Klasse
- wurden zu 100% auf Ihren Rundlauf überprüft
- verformen sich beim Herunterspannen auf den kleinsten Durchmesser nicht
- brechen nicht bei kleinen Erschütterungen
- sind auf Grund ihrer glatten Oberfläche und ihrer exakten Passform perfekt für Ihre Werkzeugaufnahme geeignet

### All **STALEX** collets

- are guaranteed within the run-out accuracy indicated for each class
- are 100% run-out accuracy checked
- are not deformed when clamped to their minimum diameter
- do not break with small shocks
- are friendly to your toolholder in term of their smooth surface free of sharp edges and their exact angle geometry to suit the chuck taper and its clamping nut

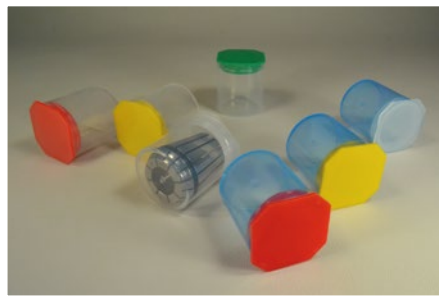

## ER-SPANNZANGENVERPACKUNG

collets packaging

**Durchsichtiger Deckel: ER-Spannzangen Klasse 2**  
(max. Rundlaufgenauigkeit 15-20  $\mu$ )

transparent cap: ER collets class 2 (max. 15-20 micron run-out accuracy)



**Gelber Deckel: ER-Spannzangen Klasse 1**  
(max. Rundlaufgenauigkeit 10  $\mu$ )

yellow cap: ER collets class 1 (max. 10 micron run-out accuracy)



**Roter Deckel: ER-Spannzangen TOPAC**  
(max. Rundlaufgenauigkeit 5  $\mu$ )

red cap: ER collets TOPAC (max. 5 micron run-out accuracy)



**Grüner Deckel: ER-Spannzangen mit 4-kant Mitnahme**  
(max. Rundlaufgenauigkeit 10  $\mu$ )

green cap: tapping ER collets (max. 10 micron run-out accuracy)



**hellblaue Plastikbox: abgedichtete ER-Spannzangen für Innenkühlung**  
light blue body: coolant sealed ER collets





## ER 8 SPANNZANGEN

ER 8 collets

D	8.5 mm
L	13 mm
Spannbereich clamping range	1.0-5.0 mm
steigend clamping steps	0.5 mm

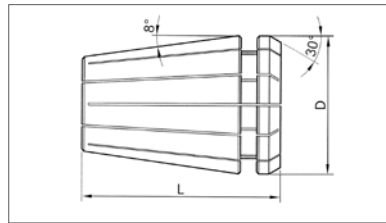

### ER 8 KLASSE 2

Bestell-Nr. order no.	Spann-Ø clamping Ø	Euro
ER080102	1.0-0.5	14,20
ER080152	1.5-1.0	14,20
ER080202	2.0-1.5	12,20
ER080252	2.5-2.0	12,20
ER080302	3.0-2.5	9,40
ER080352	3.5-3.0	9,40
ER080402	4.0-3.5	9,40
ER080452	4.5-4.0	9,40
ER080502	5.0-4.5	9,40

### ER 8 KLASSE 1

Bestell-Nr. order no.	Spann-Ø clamping Ø	Euro
ER080101	1.0-0.5	16,80
ER080151	1.5-1.0	16,80
ER080201	2.0-1.5	14,40
ER080251	2.5-2.0	14,40
ER080301	3.0-2.5	11,60
ER080351	3.5-3.0	11,60
ER080401	4.0-3.5	11,60
ER080451	4.5-4.0	11,60
ER080501	5.0-4.5	11,60

### ER 8 TOPAC (5 µ)

Bestell-Nr. order no.	Spann-Ø clamping Ø	Euro
ER08010T	1.0-0.5	24,80
ER08015T	1.5-1.0	24,80
ER08020T	2.0-1.5	20,40
ER08025T	2.5-2.0	20,40
ER08030T	3.0-2.5	16,00
ER08035T	3.5-3.0	16,00
ER08040T	4.0-3.5	16,00
ER08045T	4.5-4.0	16,00
ER08050T	5.0-4.5	16,00

## ER 8 SPANNZANGENSÄTZE (Ø 1-5 mm 9 Stück)

ER 8 collet sets (Ø 1-5 mm 9 pcs)

### ER 8 SPANNZANGENSATZ KLASSE 2

Bestell-Nr. order no.	Inhalt content	Euro
ER08SET2	9 Stück ER 8 Spannzangen Klasse 2, Ø 1-5 mm, 0,5 mm steigend, in Plastikkoffer 9 pcs ER 8 collets class 2, Ø 1-5 mm in 0.5 mm steps, in plastic case	79,00

### ER 8 SPANNZANGENSATZ KLASSE 1

Bestell-Nr. order no.	Inhalt content	Euro
ER08SET1	9 Stück ER 8 Spannzangen Klasse 1, Ø 1-5 mm, 0,5 mm steigend, in Plastikkoffer 9 pcs ER 8 collets class 1, Ø 1-5 mm in 0.5 mm steps, in plastic case	96,00

### ER 8 SPANNZANGENSATZ TOPAC

Bestell-Nr. order no.	Inhalt content	Euro
ER08SETT	9 Stück ER 8 Spannzangen TOPAC, Ø 1-5 mm, 0,5 mm steigend, in Plastikkoffer 9 pcs ER 8 collets TOPAC, Ø 1-5 mm in 0.5 mm steps, in plastic case	133,00



## ER 11 SPANNZANGEN

ER 11 collets



D	11.5 mm
L	18 mm
Spannbereich clamping range	1.0-7.0 mm
steigend clamping steps	0.5 mm

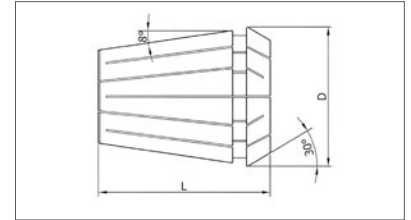

### ER 11 KLASSE 2

Bestell-Nr. order no.	Spann-Ø clamping Ø	Euro
ER110102	1.0-0.5	13,00
ER110152	1.5-1.0	13,00
ER110202	2.0-1.5	11,00
ER110252	2.5-2.0	11,00
ER110302	3.0-2.5	8,20
ER110352	3.5-3.0	8,20
ER110402	4.0-3.5	8,20
ER110452	4.5-4.0	8,20
ER110502	5.0-4.5	8,20
ER110552	5.5-5.0	8,20
ER110602	6.0-5.5	8,20
ER110652	6.5-6.0	8,20
ER110702	7.0-6.5	8,20

### ER 11 KLASSE 1

Bestell-Nr. order no.	Spann-Ø clamping Ø	Euro
ER110101	1.0-0.5	15,40
ER110151	1.5-1.0	15,40
ER110201	2.0-1.5	13,20
ER110251	2.5-2.0	13,20
ER110301	3.0-2.5	10,20
ER110351	3.5-3.0	10,20
ER110401	4.0-3.5	10,20
ER110451	4.5-4.0	10,20
ER110501	5.0-4.5	10,20
ER110551	5.5-5.0	10,20
ER110601	6.0-5.5	10,20
ER110651	6.5-6.0	10,20
ER110701	7.0-6.5	10,20

### ER 11 TOPAC (5 µ)

Bestell-Nr. order no.	Spann-Ø clamping Ø	Euro
ER11010T	1.0-0.5	23,40
ER11015T	1.5-1.0	23,40
ER11020T	2.0-1.5	19,20
ER11025T	2.5-2.0	19,20
ER11030T	3.0-2.5	14,60
ER11035T	3.5-3.0	14,60
ER11040T	4.0-3.5	14,60
ER11045T	4.5-4.0	14,60
ER11050T	5.0-4.5	14,60
ER11055T	5.5-5.0	14,60
ER11060T	6.0-5.5	14,60
ER11065T	6.5-6.0	14,60
ER11070T	7.0-6.5	14,60



## ER 11 SPANNZANGENSÄTZE (Ø 1-7 mm 13 Stück)

ER 11 collet sets (Ø 1-7 mm 13 pcs)

### ER 11 SPANNZANGENSATZ KLASSE 2

Bestell-Nr. order no.	Inhalt content	Euro
ER11SET2	13 Stück ER 11 Spannzangen Klasse 2, Ø 1-7 mm, 0,5 mm steigend, in Plastikkoffer 13 pcs ER 11 collets class 2, Ø 1-7 mm in 0.5 mm steps, in plastic case	96,00

### ER 11 SPANNZANGENSATZ KLASSE 1

Bestell-Nr. order no.	Inhalt content	Euro
ER11SET1	13 Stück ER 11 Spannzangen Klasse 1, Ø 1-7 mm, 0,5 mm steigend, in Plastikkoffer 13 pcs ER 11 collets class 1, Ø 1-7 mm in 0.5 mm steps, in plastic case	117,00

### ER 11 SPANNZANGENSATZ TOPAC

Bestell-Nr. order no.	Inhalt content	Euro
ER11SETT	13 Stück ER 11 Spannzangen TOPAC, Ø 1-7 mm, 0,5 mm steigend, in Plastikkoffer 13 pcs ER 11 collets TOPAC, Ø 1-7 mm in 0.5 mm steps, in plastic case	168,00

## ER 16 SPANNZANGEN

ER 16 collets

D	17 mm
L	27.5 mm
Spannbereich clamping range	1.0-10.0 mm
steigend clamping steps	1.0 mm

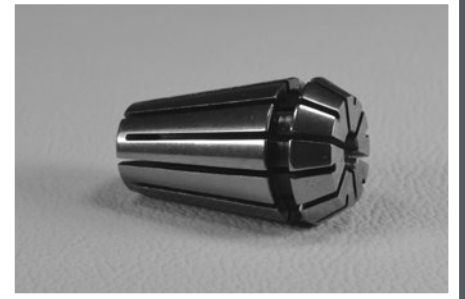
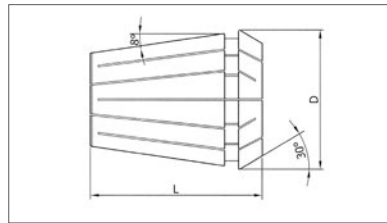

### ER 16 KLASSE 2

Bestell-Nr. order no.	Spann-Ø clamping Ø	Euro
ER160102	1.0-0.5	10,40
ER160152	1.5-1.0	10,40
ER160202	2.0-1.5	8,60
ER160252	2.5-2.0	8,60
ER160302	3.0-2.5	6,60
ER160352	3.5-2.5	8,60
ER160402	4.0-3.0	6,60
ER160452	4.5-3.5	8,60
ER160502	5.0-4.0	6,60
ER160552	5.5-4.5	8,60
ER160602	6.0-5.0	6,60
ER160652	6.5-5.5	8,60
ER160702	7.0-6.0	6,60
ER160752	7.5-6.5	8,60
ER160802	8.0-7.0	6,60
ER160852	8.5-7.5	8,60
ER160902	9.0-8.0	6,60
ER160952	9.5-8.5	8,60
ER161002	10.0-9.0	6,60

### ER 16 KLASSE 1

Bestell-Nr. order no.	Spann-Ø clamping Ø	Euro
ER160101	1.0-0.5	13,80
ER160151	1.5-1.0	13,80
ER160201	2.0-1.5	11,60
ER160251	2.5-2.0	11,60
ER160301	3.0-2.5	9,20
ER160351	3.5-2.5	11,20
ER160401	4.0-3.0	9,20
ER160451	4.5-3.5	11,20
ER160501	5.0-4.0	9,20
ER160551	5.5-4.5	11,20
ER160601	6.0-5.0	9,20
ER160651	6.5-5.5	11,20
ER160701	7.0-6.0	9,20
ER160751	7.5-6.5	11,20
ER160801	8.0-7.0	9,20
ER160851	8.5-7.5	11,20
ER160901	9.0-8.0	9,20
ER160951	9.5-8.5	11,20
ER161001	10.0-9.0	9,20

### ER 16 TOPAC (5 µ)

Bestell-Nr. order no.	Spann-Ø clamping Ø	Euro
ER16010T	1.0-0.5	21,40
ER16015T	1.5-1.0	21,40
ER16020T	2.0-1.5	17,20
ER16025T	2.5-2.0	17,20
ER16030T	3.0-2.5	13,00
ER16035T	3.5-2.5	15,00
ER16040T	4.0-3.0	13,00
ER16045T	4.5-3.5	15,00
ER16050T	5.0-4.0	13,00
ER16055T	5.5-4.5	15,00
ER16060T	6.0-5.0	13,00
ER16065T	6.5-5.5	15,00
ER16070T	7.0-6.0	13,00
ER16075T	7.5-6.5	15,00
ER16080T	8.0-7.0	13,00
ER16085T	8.5-7.5	15,00
ER16090T	9.0-8.0	13,00
ER16095T	9.5-8.5	15,00
ER16100T	10.0-9.0	13,00

## ER 16 SPANNZANGENSÄTZE (Ø 1-10 mm 10 Stück)

ER 16 collet sets (Ø 1-10 mm 10 pcs)

### ER 16 COLLET SET KLASSE 2

Bestell-Nr. order no.	Inhalt content	Euro
ER16SET2	10 Stück ER 16 Spannzangen Klasse 2, Ø 1-10 mm, 1,0 mm steigend, in Plastikkoffer 10 pcs ER 16 collets class 2, Ø 1-10 mm in 1.0 mm steps, in plastic case	59,00

### ER 16 COLLET SET KLASSE 1

Bestell-Nr. order no.	Inhalt content	Euro
ER16SET1	10 Stück ER 16 Spannzangen Klasse 1, Ø 1-10 mm, 1,0 mm steigend, in Plastikkoffer 10 pcs ER 16 collets class 1, Ø 1-10 mm in 1.0 mm steps, in plastic case	79,00

### ER 16 COLLET SET TOPAC

Bestell-Nr. order no.	Inhalt content	Euro
ER16SETT	10 Stück ER 16 Spannzangen TOPAC, Ø 1-10 mm, 1,0 mm steigend, in Plastikkoffer 10 pcs ER 16 collets TOPAC, Ø 1-10 mm in 1.0 mm steps, in plastic case	112,00



## ER 20 SPANNZANGEN

ER 20 collets



D	21 mm
L	31.5 mm
Spannbereich clamping range	1.0-13.0 mm
steigend clamping steps	1.0 mm

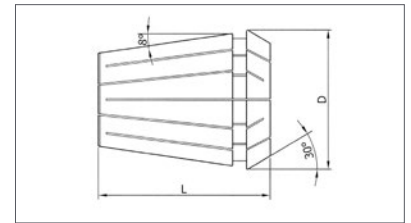

### ER 20 KLASSE 2

Bestell-Nr. order no.	Spann-Ø clamping Ø	Euro
ER200102	1.0-0.5	11,00
ER200152	1.5-1.0	11,00
ER200202	2.0-1.5	9,60
ER200252	2.5-2.0	9,60
ER200302	3.0-2.5	7,00
ER200352	3.5-2.5	9,60
ER200402	4.0-3.0	7,00
ER200452	4.5-3.5	9,60
ER200502	5.0-4.0	7,00
ER200602	6.0-5.0	7,00
ER200702	7.0-6.0	7,00
ER200802	8.0-7.0	7,00
ER200902	9.0-8.0	7,00
ER201002	10.0-9.0	7,00
ER201102	11.0-10.0	7,00
ER201202	12.0-11.0	7,00
ER201302	13.0-12.0	7,00

### ER 20 KLASSE 1

Bestell-Nr. order no.	Spann-Ø clamping Ø	Euro
ER200101	1.0-0.5	14,40
ER200151	1.5-1.0	14,40
ER200201	2.0-1.0	12,80
ER202521	2.5-2.0	12,80
ER200301	3.0-2.5	9,80
ER200351	3.5-2.5	12,40
ER200401	4.0-3.0	9,80
ER200451	4.5-3.5	12,40
ER200501	5.0-4.0	9,80
ER200601	6.0-5.0	9,80
ER200701	7.0-6.0	9,80
ER200801	8.0-7.0	9,80
ER200901	9.0-8.0	9,80
ER201001	10.0-9.0	9,80
ER201101	11.0-10.0	9,80
ER201201	12.0-11.0	9,80
ER201301	13.0-12.0	9,80

### ER 20 TOPAC (5 µ)

Bestell-Nr. order no.	Spann-Ø clamping Ø	Euro
ER20010T	1.0-0.5	22,00
ER20015T	1.5-1.0	22,00
ER20020T	2.0-1.0	18,40
ER20252T	2.5-2.0	18,40
ER20030T	3.0-2.5	13,40
ER20035T	3.5-2.5	16,00
ER20040T	4.0-3.0	13,40
ER20045T	4.5-3.5	16,00
ER20050T	5.0-4.0	13,40
ER20060T	6.0-5.0	13,40
ER20070T	7.0-6.0	13,40
ER20080T	8.0-7.0	13,40
ER20090T	9.0-8.0	13,40
ER20100T	10.0-9.0	13,40
ER20110T	11.0-10.0	13,40
ER20120T	12.0-11.0	13,40
ER20130T	13.0-12.0	13,40



## ER 20 SPANNZANGENSÄTZE (Ø 2-13 mm 12 Stück)

ER 20 collet sets (Ø 2-13 mm 12 pcs)

### ER 20 SPANNZANGENSATZ KLASSE 2

Bestell-Nr. order no.	Inhalt content	Euro
ER20SET2	12 Stück ER 20 Spannzangen Klasse 2, Ø 2-13 mm, 1,0 mm steigend, in Plastikkoffer 12 pcs ER 20 collets class 2, Ø 2-13 mm in 1.0 mm steps, in plastic case	69,00

### ER 20 SPANNZANGENSATZ KLASSE 1

Bestell-Nr. order no.	Inhalt content	Euro
ER20SET1	12 Stück ER 20 Spannzangen Klasse 1, Ø 2-13 mm, 1,0 mm steigend, in Plastikkoffer 12 pcs ER 20 collets class 1, Ø 2-13 mm in 1.0 mm steps, in plastic case	96,00

### ER 20 SPANNZANGENSATZ TOPAC

Bestell-Nr. order no.	Inhalt content	Euro
ER20SETT	12 Stück ER 20 Spannzangen TOPAC, Ø 2-13 mm, 1,0 mm steigend, in Plastikkoffer 12 pcs ER 20 collets TOPAC, Ø 2-13 mm in 1.0 mm steps, in plastic case	129,00

## ER 25 SPANNZANGEN

ER 25 collets

D	26 mm
L	34 mm
Spannbereich clamping range	1.0-16.0 mm
steigend clamping steps	1.0 mm

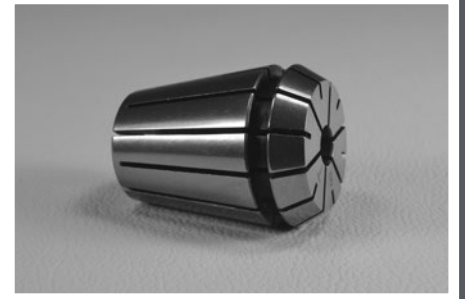
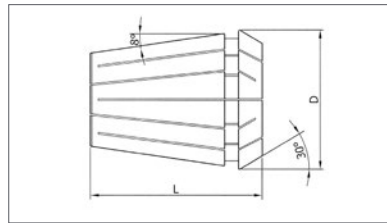

### ER 25 KLASSE 2

Bestell-Nr. order no.	Spann-Ø clamping Ø	Euro
ER250102	1.0-0.5	13,00
ER250152	1.5-1.0	13,00
ER250202	2.0-1.0	10,00
ER250252	2.5-2.0	10,00
ER250302	3.0-2.5	7,60
ER250352	3.5-2.5	10,00
ER250402	4.0-3.0	7,60
ER250452	4.5-3.5	10,00
ER250502	5.0-4.0	7,60
ER250602	6.0-5.0	7,60
ER250702	7.0-6.0	7,60
ER250802	8.0-7.0	7,60
ER250902	9.0-8.0	7,60
ER251002	10.0-9.0	7,60
ER251102	11.0-10.0	7,60
ER251202	12.0-11.0	7,60
ER251302	13.0-12.0	7,60
ER251402	14.0-13.0	7,60
ER251502	15.0-14.0	7,60
ER251602	16.0-15.0	7,60

### ER 25 KLASSE 1

Bestell-Nr. order no.	Spann-Ø clamping Ø	Euro
ER250101	1.0-0.5	16,40
ER250151	1.5-1.0	16,40
ER250201	2.0-1.0	13,20
ER250251	2.5-2.0	13,20
ER250301	3.0-2.5	10,40
ER250351	3.5-2.5	12,80
ER250401	4.0-3.0	10,40
ER250451	4.5-3.5	12,80
ER250501	5.0-4.0	10,40
ER250601	6.0-5.0	10,40
ER250701	7.0-6.0	10,40
ER250801	8.0-7.0	10,40
ER250901	9.0-8.0	10,40
ER251001	10.0-9.0	10,40
ER251101	11.0-10.0	10,40
ER251201	12.0-11.0	10,40
ER251301	13.0-12.0	10,40
ER251401	14.0-13.0	10,40
ER251501	15.0-14.0	10,40
ER251601	16.0-15.0	10,40

### ER 25 TOPAC (5 µ)

Bestell-Nr. order no.	Spann-Ø clamping Ø	Euro
ER25010T	1.0-0.5	24,00
ER25015T	1.5-1.0	24,00
ER25020T	2.0-1.0	18,80
ER25025T	2.5-2.0	18,80
ER25030T	3.0-2.5	14,00
ER25035T	3.5-2.5	16,40
ER25040T	4.0-3.0	14,00
ER25045T	4.5-3.5	16,40
ER25050T	5.0-4.0	14,00
ER25060T	6.0-5.0	14,00
ER25070T	7.0-6.0	14,00
ER25080T	8.0-7.0	14,00
ER25090T	9.0-8.0	14,00
ER25100T	10.0-9.0	14,00
ER25110T	11.0-10.0	14,00
ER25120T	12.0-11.0	14,00
ER25130T	13.0-12.0	14,00
ER25140T	14.0-13.0	14,00
ER25150T	15.0-14.0	14,00
ER25160T	16.0-15.0	14,00

## ER 25 SPANNZANGENSÄTZE (Ø 2-16 mm 15 Stück)

ER 25 collet sets (Ø 2-16 mm 15 pcs)

### ER 25 SPANNZANGENSATZ KLASSE 2

Bestell-Nr. order no.	Inhalt content	Euro
ER25SET2	15 Stück ER 25 Spannzangen Klasse 2, Ø 2-16 mm, 1,0 mm steigend, in Plastikkoffer 15 pcs ER 25 collets class 2, Ø 2-16 mm in 1.0 mm steps, in plastic case	96,00

### ER 25 SPANNZANGENSATZ KLASSE 1

Bestell-Nr. order no.	Inhalt content	Euro
ER25SET1	15 Stück ER 25 Spannzangen Klasse 1, Ø 2-16 mm, 1,0 mm steigend, in Plastikkoffer 15 pcs ER 25 collets class 1, Ø 2-16 mm in 1.0 mm steps, in plastic case	128,00

### ER 25 SPANNZANGENSATZ TOPAC

Bestell-Nr. order no.	Inhalt content	Euro
ER25SETT	15 Stück ER 25 Spannzangen TOPAC, Ø 2-16 mm, 1,0 mm steigend, in Plastikkoffer 15 pcs ER 25 collets TOPAC, Ø 2-16 mm in 1.0 mm steps, in plastic case	169,00



## ER 32 SPANNZANGEN

ER 32 collets



D	33 mm
L	40 mm
Spannbereich clamping range	1.0-25.0 mm
steigend clamping steps	1.0 mm

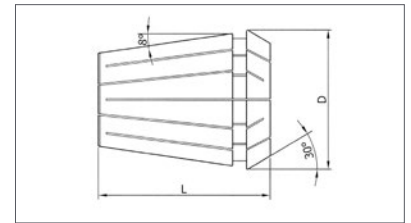

### ER 32 KLASSE 2

Bestell-Nr. order no.	Spann-Ø clamping Ø	Euro
ER320102	1.0-0.5	16,60
ER320152	1.5-1.0	16,60
ER320202	2.0-1.5	13,60
ER320252	2.5-2.0	13,60
ER320302	3.0-2.5	8,00
ER320352	3.5-2.5	11,60
ER320402	4.0-3.0	8,00
ER320452	4.5-3.5	11,60
ER320502	5.0-4.0	8,00
ER320602	6.0-5.0	8,00
ER320702	7.0-6.0	8,00
ER320802	8.0-7.0	8,00
ER320902	9.0-8.0	8,00
ER321002	10.0-9.0	8,00
ER321102	11.0-10.0	8,00
ER321202	12.0-11.0	8,00
ER321302	13.0-12.0	8,00
ER321402	14.0-13.0	8,00
ER321502	15.0-14.0	8,00
ER321602	16.0-15.0	8,00
ER321702	17.0-16.0	8,00
ER321802	18.0-17.0	8,00
ER321902	19.0-18.0	8,00
ER322002	20.0-19.0	8,00
ER322502	25.0-24.0	18,00

### ER 32 KLASSE 1

Bestell-Nr. order no.	Spann-Ø clamping Ø	Euro
ER320101	1.0-0.5	20,60
ER320151	1.5-1.0	20,60
ER320151	2.0-1.5	17,60
ER320251	2.5-2.0	17,60
ER320301	3.0-2.5	11,20
ER320352	3.5-2.5	14,80
ER320401	4.0-3.0	11,20
ER320451	4.5-3.5	14,80
ER320501	5.0-4.0	11,20
ER320601	6.0-5.0	11,20
ER320701	7.0-6.0	11,20
ER320801	8.0-7.0	11,20
ER320901	9.0-8.0	11,20
ER321001	10.0-9.0	11,20
ER321101	11.0-10.0	11,20
ER321201	12.0-11.0	11,20
ER321301	13.0-12.0	11,20
ER321401	14.0-13.0	11,20
ER321501	15.0-14.0	11,20
ER321601	16.0-15.0	11,20
ER321701	17.0-16.0	11,20
ER321801	18.0-17.0	11,20
ER321901	19.0-18.0	11,20
ER322001	20.0-19.0	11,20
ER322501	25.0-24.0	21,00

### ER 32 TOPAC (5 µ)

Bestell-Nr. order no.	Spann-Ø clamping Ø	Euro
ER32010T	1.0-0.5	25,00
ER32015T	1.5-1.0	25,00
ER32015T	2.0-1.5	22,00
ER32025T	2.5-2.0	22,00
ER32030T	3.0-2.5	14,60
ER320352	3.5-2.5	18,20
ER32040T	4.0-3.0	14,60
ER32045T	4.5-3.5	18,20
ER32050T	5.0-4.0	14,60
ER32060T	6.0-5.0	14,60
ER32070T	7.0-6.0	14,60
ER32080T	8.0-7.0	14,60
ER32090T	9.0-8.0	14,60
ER32100T	10.0-9.0	14,60
ER32110T	11.0-10.0	14,60
ER32120T	12.0-11.0	14,60
ER32130T	13.0-12.0	14,60
ER32140T	14.0-13.0	14,60
ER32150T	15.0-14.0	14,60
ER32160T	16.0-15.0	14,60
ER32170T	17.0-16.0	14,60
ER32180T	18.0-17.0	14,60
ER32190T	19.0-18.0	14,60
ER32200T	20.0-19.0	14,60
ER32250T	25.0-24.0	29,00

Die Länge der ER 32 Ø 25 mm beträgt 32,5 mm.

The length of ER 32 Ø 25 mm collet is 32.5 mm.



## ER 32 SPANNZANGENSÄTZE (Ø 3-20 mm 18 Stück)

ER 32 collet sets (Ø 3-20 mm 18 pcs)

### ER 32 SPANNZANGENSATZ KLASSE 2

Bestell-Nr. order no.	Inhalt content	Euro
ER32SET2	18 Stück ER 32 Spannzangen Klasse 2, Ø 3-20 mm, 1,0 mm steigend, in Plastikkoffer 18 pcs ER 32 collets class 2, Ø 3-20 mm in 1.0 mm steps, in plastic case	119,00

### ER 32 SPANNZANGENSATZ KLASSE 1

Bestell-Nr. order no.	Inhalt content	Euro
ER32SET1	18 Stück ER 32 Spannzangen Klasse 1, Ø 3-20 mm, 1,0 mm steigend, in Plastikkoffer 18 pcs ER 32 collets class 1, Ø 3-20 mm in 1.0 mm steps, in plastic case	162,00

### ER 32 SPANNZANGENSATZ TOPAC

Bestell-Nr. order no.	Inhalt content	Euro
ER32SETT	18 Stück ER 32 Spannzangen TOPAC, Ø 3-20 mm, 1,0 mm steigend, in Plastikkoffer 18 pcs ER 32 collets TOPAC, Ø 3-20 mm in 1.0 mm steps, in plastic case	208,00

## ER 40 SPANNZANGEN

ER 40 collets

D	41 mm
L	46 mm
Spannbereich clamping range	2.0-32.0 mm
steigend clamping steps	1.0 mm

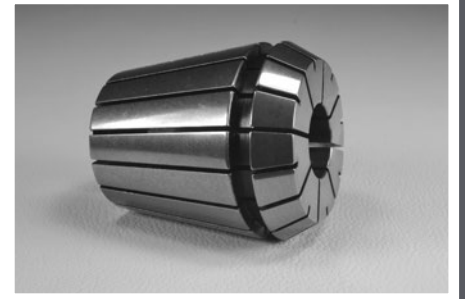
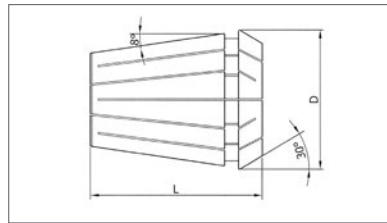

### ER 40 KLASSE 2

Bestell-Nr. order no.	Spann-Ø clamping Ø	Euro
ER400202	2.0-1.5	17,00
ER400252	2.5-2.0	17,00
ER400302	3.0-2.5	13,80
ER400352	3.5-2.5	13,80
ER400402	4.0-3.0	9,80
ER400452	4.5-3.5	13,80
ER400502	5.0-4.0	9,80
ER400602	6.0-5.0	9,80
ER400702	7.0-6.0	9,80
ER400802	8.0-7.0	9,80
ER400902	9.0-8.0	9,80
ER401002	10.0-9.0	9,80
ER401102	11.0-10.0	9,80
ER401202	12.0-11.0	9,80
ER401302	13.0-12.0	9,80
ER401402	14.0-13.0	9,80
ER401502	15.0-14.0	9,80
ER401602	16.0-15.0	9,80
ER401702	17.0-16.0	9,80
ER401802	18.0-17.0	9,80
ER401902	19.0-18.0	9,80
ER402002	20.0-19.0	9,80
ER402102	21.0-20.0	9,80
ER402202	22.0-21.0	9,80
ER402302	23.0-22.0	9,80
ER402402	24.0-23.0	9,80
ER402502	25.0-24.0	9,80
ER402602	26.0-25.0	9,80
ER403002	30.0-29.0	22,00
ER403202	32.0-31.0	22,00

### ER 40 KLASSE 1

Bestell-Nr. order no.	Spann-Ø clamping Ø	Euro
ER400201	2.0-1.5	20,80
ER400251	2.5-2.0	20,80
ER400301	3.0-2.5	17,60
ER400351	3.5-2.5	17,60
ER400401	4.0-3.0	13,60
ER400451	4.5-3.5	17,60
ER400501	5.0-4.0	13,60
ER400601	6.0-5.0	13,60
ER400701	7.0-6.0	13,60
ER400801	8.0-7.0	13,60
ER400901	9.0-8.0	13,60
ER401001	10.0-9.0	13,60
ER401101	11.0-10.0	13,60
ER401201	12.0-11.0	13,60
ER401301	13.0-12.0	13,60
ER401401	14.0-13.0	13,60
ER401501	15.0-14.0	13,60
ER401601	16.0-15.0	13,60
ER401701	17.0-16.0	13,60
ER401801	18.0-17.0	13,60
ER401901	19.0-18.0	13,60
ER402001	20.0-19.0	13,60
ER402101	21.0-20.0	13,60
ER402201	22.0-21.0	13,60
ER402301	23.0-22.0	13,60
ER402401	24.0-23.0	13,60
ER402501	25.0-24.0	13,60
ER402601	26.0-25.0	13,60
ER403001	30.0-29.0	25,80
ER403201	32.0-31.0	25,80

### ER 40 TOPAC (5 µ)

Bestell-Nr. order no.	Spann-Ø clamping Ø	Euro
ER40020T	2.0-1.5	24,60
ER40025T	2.5-2.0	24,60
ER40030T	3.0-2.5	21,40
ER40035T	3.5-2.5	21,40
ER40040T	4.0-3.0	17,40
ER40045T	4.5-3.5	21,40
ER40050T	5.0-4.0	17,40
ER40060T	6.0-5.0	17,40
ER40070T	7.0-6.0	17,40
ER40080T	8.0-7.0	17,40
ER40090T	9.0-8.0	17,40
ER40100T	10.0-9.0	17,40
ER40110T	11.0-10.0	17,40
ER40120T	12.0-11.0	17,40
ER40130T	13.0-12.0	17,40
ER40140T	14.0-13.0	17,40
ER40150T	15.0-14.0	17,40
ER40160T	16.0-15.0	17,40
ER40170T	17.0-16.0	17,40
ER40180T	18.0-17.0	17,40
ER40190T	19.0-18.0	17,40
ER40200T	20.0-19.0	17,40
ER40210T	21.0-20.0	17,40
ER40220T	22.0-21.0	17,40
ER40230T	23.0-22.0	17,40
ER40240T	24.0-23.0	17,40
ER40250T	25.0-24.0	17,40
ER40260T	26.0-25.0	17,40
ER40300T	30.0-29.0	33,80
ER40320T	32.0-31.0	33,80

Die Länge der ER 40 Ø 30 mm beträgt 39 mm.  
Die Länge der ER 40 Ø 32 mm beträgt 33 mm.

The length of ER 40 Ø 30 mm collet is 39 mm.  
The length of ER 40 Ø 32 mm collet is 33 mm.

## ER 40 SPANNZANGENSÄTZE (Ø 4-26 mm 23 Stück)

ER 40 collet sets (Ø 4-26 mm 23 pcs)

### ER 40 SPANNZANGENSATZ KLASSE 2

Bestell-Nr. order no.	Inhalt content	Euro
ER40SET2	23 Stück ER 40 Spannzangen Klasse 2, Ø 4-26 mm, 1,0 mm steigend, in Plastikkoffer 23 pcs ER 40 collets class 2, Ø 4-26 mm in 1.0 mm steps, in plastic case	188,00

### ER 40 SPANNZANGENSATZ KLASSE 1

Bestell-Nr. order no.	Inhalt content	Euro
ER40SET1	23 Stück ER 40 Spannzangen Klasse 1, Ø 4-26 mm, 1,0 mm steigend, in Plastikkoffer 23 pcs ER 40 collets class 1, Ø 4-26 mm in 1.0 mm steps, in plastic case	254,00

### ER 40 SPANNZANGENSATZ TOPAC

Bestell-Nr. order no.	Inhalt content	Euro
ER40SETT	23 Stück ER 40 Spannzangen TOPAC, Ø 4-26 mm, 1,0 mm steigend, in Plastikkoffer 23 pcs ER 40 collets TOPAC, Ø 4-26 mm in 1.0 mm steps, in plastic case	319,00



## ER 50 SPANNZANGEN

ER 50 collets



D	52 mm
L	60 mm
Spannbereich clamping range	12.0-34.0 mm
steigend clamping steps	2.0 mm

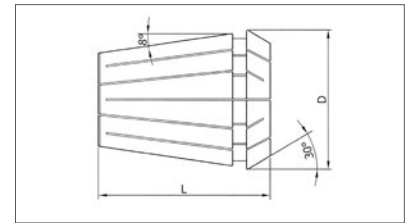

### ER 50 KLASSE 2

Bestell-Nr. order no.	Spann-Ø clamping Ø	Euro
ER501202	12.0-10.0	28,60
ER501402	14.0-12.0	28,60
ER501602	16.0-14.0	28,60
ER501802	18.0-16.0	28,60
ER502002	20.0-18.0	28,60
ER502202	22.0-20.0	28,60
ER502402	24.0-22.0	28,60
ER502502	25.0-23.0	28,60
ER502602	26.0-24.0	28,60
ER502802	28.0-26.0	28,60
ER503002	30.0-28.0	28,60
ER503202	32.0-30.0	28,60
ER503402	34.0-32.0	28,60

### ER 50 KLASSE 1

Bestell-Nr. order no.	Spann-Ø clamping Ø	Euro
ER501201	12.0-10.0	33,60
ER501401	14.0-12.0	33,60
ER501601	16.0-14.0	33,60
ER501801	18.0-16.0	33,60
ER502001	20.0-18.0	33,60
ER502201	22.0-20.0	33,60
ER502401	24.0-22.0	33,60
ER502501	25.0-23.0	33,60
ER502601	26.0-24.0	33,60
ER502801	28.0-26.0	33,60
ER503001	30.0-28.0	33,60
ER503201	32.0-30.0	33,60
ER503401	34.0-32.0	33,60

### ER 50 TOPAC (5 µ)

Bestell-Nr. order no.	Spann-Ø clamping Ø	Euro
ER50120T	12.0-10.0	40,60
ER50140T	14.0-12.0	40,60
ER50160T	16.0-14.0	40,60
ER50180T	18.0-16.0	40,60
ER50200T	20.0-18.0	40,60
ER50220T	22.0-20.0	40,60
ER50240T	24.0-22.0	40,60
ER50250T	25.0-23.0	40,60
ER50260T	26.0-24.0	40,60
ER50280T	28.0-26.0	40,60
ER50300T	30.0-28.0	40,60
ER50320T	32.0-30.0	40,60
ER50340T	34.0-32.0	40,60



## ER 50 SPANNZANGENSÄTZE (Ø 12-34 mm 12 Stück)

ER 50 collet sets (Ø 12-34 mm 12 pcs)

### ER 50 SPANNZANGENSATZ KLASSE 2

Bestell-Nr. order no.	Inhalt content	Euro
ER50SET2	12 Stück ER 50 Spannzangen Klasse 2, Ø 12-34 mm, 2,0 mm steigend, in Plastikkoffer 12 pcs ER 50 collets class 2, Ø 12-34 mm in 2.0 mm steps, in plastic case	278,00

### ER 50 SPANNZANGENSATZ KLASSE 1

Bestell-Nr. order no.	Inhalt content	Euro
ER50SET1	12 Stück ER 50 Spannzangen Klasse 1, Ø 12-34 mm, 2,0 mm steigend, in Plastikkoffer 12 pcs ER 50 collets class 1, Ø 12-34 mm in 2.0 mm steps, in plastic case	323,00

### ER 50 SPANNZANGENSATZ TOPAC

Bestell-Nr. order no.	Inhalt content	Euro
ER50SETT	12 Stück ER 50 Spannzangen TOPAC, Ø 12-34 mm, 2,0 mm steigend, in Plastikkoffer 12 pcs ER 50 collets TOPAC, Ø 12-34 mm in 2.0 mm steps, in plastic case	386,00

Normalerweise enthalten ER 50 Spannzangensätze keine Zange mit Ø 25 mm. Diese können wir auf Anfrage anstatt Ø 26 mm liefern.

Normally all ER 50 sets do not contain Ø 25 mm collet. It can be included in the set instead of Ø 26 mm if requested.





**ER-SPANNZANGEN ABGEDICHTET  
ER-SPANNZANGEN MIT VIERKANTMITNAHME  
ER-SPANNZANGEN ZOLLABMESSUNGEN  
OZ 25 SPANNZANGEN DIN 6388B**

coolant sealed ER collets  
tapping ER collets  
inch sized ER collets  
OZ 25 collets DIN 6388B

## ER-SPANNZANGEN ABGEDICHTET (Für Innenkühlung)

coolant sealed ER collets (for internal coolant)

Pat. Nr. 2013/00719

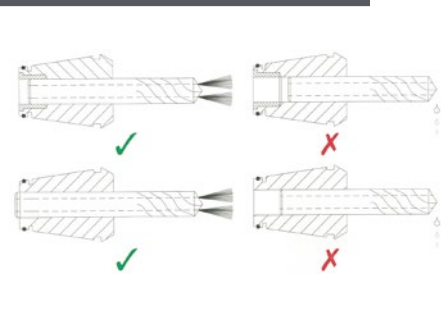
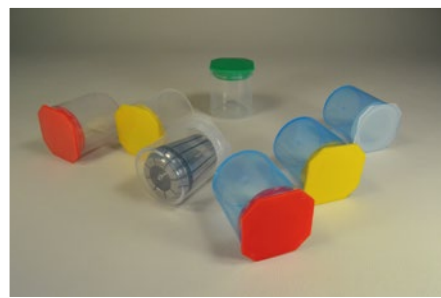
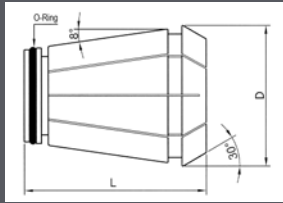

### ERC 16 SPANNZANGEN ABGEDICHTET

ERC 16 coolant sealed collets

D = 17 / L = 27.5

#### ER 16 KLASSE 2

Bestell-Nr. order no.	Spann-Ø clamping Ø	Euro
ERC160302	3	18,60
ERC160402	4	18,60
ERC160502	5	18,60
ERC160602	6	18,60
ERC160702	7	18,60
ERC160802	8	18,60
ERC160902	9	18,60
ERC161002	10	18,60

#### ER 16 KLASSE 1

Bestell-Nr. order no.	Spann-Ø clamping Ø	Euro
ERC160301	3	21,20
ERC160401	4	21,20
ERC160501	5	21,20
ERC160601	6	21,20
ERC160701	7	21,20
ERC160801	8	21,20
ERC160901	9	21,20
ERC161001	10	21,20

#### ER 16 TOPAC (5 µ)

Bestell-Nr. order no.	Spann-Ø clamping Ø	Euro
ERC16030T	3	26,20
ERC16040T	4	26,20
ERC16050T	5	26,20
ERC16060T	6	26,20
ERC16070T	7	26,20
ERC16080T	8	26,20
ERC16090T	9	26,20
ERC16100T	10	26,20

### ERC 16 SPANNZANGENSÄTZE ABGEDICHTET

ERC 16 coolant sealed collet sets

#### ERC 16 SPANNZANGENSATZ ABGEDICHTET KLASSE 2

Bestell-Nr. order no.	Inhalt content	Euro
ERC16SET2	8 Stück ERC 16 Spannanzangen abgedichtet Klasse 2, Ø 3-10 mm, 1,0 mm steigend, in Plastikkoffer 8 pcs ERC 16 coolant sealed collets class 2, Ø 3-10 mm in 1.0 mm steps, in plastic case	117,00

#### ERC 16 SPANNZANGENSATZ ABGEDICHTET KLASSE 1

Bestell-Nr. order no.	Inhalt content	Euro
ERC16SET1	8 Stück ERC 16 Spannanzangen abgedichtet Klasse 1, Ø 3-10 mm, 1,0 mm steigend, in Plastikkoffer 8 pcs ERC 16 coolant sealed collets class 1, Ø 3-10 mm in 1.0 mm steps, in plastic case	132,00

#### ERC 16 SPANNZANGENSATZ ABGEDICHTET TOPAC

Bestell-Nr. order no.	Inhalt content	Euro
ERC16SETT	8 Stück ERC 16 Spannanzangen abgedichtet TOPAC, Ø 3-10 mm, 1,0 mm steigend, in Plastikkoffer 8 pcs ERC 16 coolant sealed collets TOPAC, Ø 3-10 mm in 1.0 mm steps, in plastic case	162,00

#### EIGENSCHAFTEN ERC SPANNZANGEN ABGEDICHTET

Innenkühlung nur unter Spannung der Zange.

Der Schaft des Werkzeugs muss bis ans Ende der abgedichteten Spannanzange eingeführt werden (siehe Anweisung).

Geeignet für alle ER-Spannanzangenaufnahmen.

Kann auch als Standard ER-Spannanzange ohne Innenkühlung eingesetzt werden.

Weniger flexibel mit härterer Struktur im Gegensatz zu Standard ER-Spannanzangen.

Andere Abmessungen auf Anfrage.

Höhere Spannkraft im Gegensatz zu Standard ER-Spannanzangen für besseren Halt und mehr Präzision.

#### FEATURES OF COOLANT SEALED ER COLLETS

Coolant sealed performance only when clamped the nominal diameter.

The shank should be inserted till the back end of the collet as shown in the instruction.

Suitable for all kinds of ER collet holders.

May also be used as standard ER collet for the nominal diameter cutters without internal coolant.

Less flexible with harder structure compared with standard ER collets.

Other sizes are available on request.

Apply a little higher clamping torque than standard ER application for better grip & precision.

**ERC 20 SPANNZANGEN ABGEDICHTET**

D = 21 / L = 31.5

ERC 20 coolant sealed collets

**ERC 20 KLASSE 2**

Bestell-Nr. order no.	Spann-Ø clamping Ø	Euro
ERC200302	3	18,80
ERC200402	4	18,80
ERC200502	5	18,80
ERC200602	6	18,80
ERC200702	7	18,80
ERC200802	8	18,80
ERC200902	9	18,80
ERC201002	10	18,80
ERC201102	11	18,80
ERC201202	12	18,80
ERC201302	13	18,80

**ERC 20 KLASSE 1**

Bestell-Nr. order no.	Spann-Ø clamping Ø	Euro
ERC200301	3	21,40
ERC200401	4	21,40
ERC200501	5	21,40
ERC200601	6	21,40
ERC200701	7	21,40
ERC200801	8	21,40
ERC200901	9	21,40
ERC201001	10	21,40
ERC201101	11	21,40
ERC201201	12	21,40
ERC201301	13	21,40

**ERC 20 TOPAC (5 µ)**

Bestell-Nr. order no.	Spann-Ø clamping Ø	Euro
ERC20030T	3	26,40
ERC20040T	4	26,40
ERC20050T	5	26,40
ERC20060T	6	26,40
ERC20070T	7	26,40
ERC20080T	8	26,40
ERC20090T	9	26,40
ERC20100T	10	26,40
ERC20110T	11	26,40
ERC20120T	12	26,40
ERC20130T	13	26,40

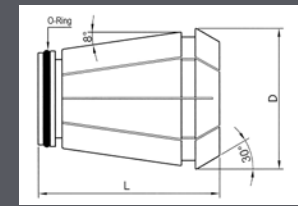
**ERC 20 SPANNZANGENSATZ ABGEDICHTET KLASSE 2**

Bestell-Nr. order no.	Inhalt content	Euro
ERC20SET2	11 Stück ERC 20 Spannanzgen abgedichtet Klasse 2, Ø 3-13 mm, 1,0 mm steigend, in Plastikkoffer 11 pcs ERC 20 coolant sealed collets class 2, Ø 3-13 mm in 1.0 mm steps, in plastic case	161,00

**ERC 20 SPANNZANGENSATZ ABGEDICHTET KLASSE 1**

Bestell-Nr. order no.	Inhalt content	Euro
ERC20SET1	11 Stück ERC 20 Spannanzgen abgedichtet Klasse 1, Ø 3-13 mm, 1,0 mm steigend, in Plastikkoffer 11 pcs ERC 20 coolant sealed collets class 1, Ø 3-13 mm in 1.0 mm steps, in plastic case	182,00

**ERC 20 SPANNZANGENSATZ ABGEDICHTET TOPAC**

Bestell-Nr. order no.	Inhalt content	Euro
ERC20SETT	11 Stück ERC 20 Spannanzgen abgedichtet TOPAC, Ø 3-13 mm, 1,0 mm steigend, in Plastikkoffer 11 pcs ERC 20 coolant sealed collets TOPAC, Ø 3-13 mm in 1.0 mm steps, in plastic case	223,00

**ERC 25 SPANNZANGEN ABGEDICHTET**

D = 26 / L = 34

ERC 25 coolant sealed collets

**ERC 25 KLASSE 2**

Bestell-Nr. order no.	Spann-Ø clamping Ø	Euro
ERC250302	3	20,00
ERC250402	4	20,00
ERC250502	5	20,00
ERC250602	6	20,00
ERC250702	7	20,00
ERC250802	8	20,00
ERC250902	9	20,00
ERC251002	10	20,00
ERC251102	11	20,00
ERC251202	12	20,00
ERC251302	13	20,00
ERC251402	14	20,00
ERC251502	15	20,00
ERC251602	16	20,00

**ERC 25 KLASSE 1**

Bestell-Nr. order no.	Spann-Ø clamping Ø	Euro
ERC250301	3	22,60
ERC250401	4	22,60
ERC250501	5	22,60
ERC250601	6	22,60
ERC250701	7	22,60
ERC250801	8	22,60
ERC250901	9	22,60
ERC251001	10	22,60
ERC251101	11	22,60
ERC251201	12	22,60
ERC251301	13	22,60
ERC251401	14	22,60
ERC251501	15	22,60
ERC251601	16	22,60

**ERC 25 TOPAC (5 µ)**

Bestell-Nr. order no.	Spann-Ø clamping Ø	Euro
ERC25030T	3	27,60
ERC25040T	4	27,60
ERC25050T	5	27,60
ERC25060T	6	27,60
ERC25070T	7	27,60
ERC25080T	8	27,60
ERC25090T	9	27,60
ERC25100T	10	27,60
ERC25110T	11	27,60
ERC25120T	12	27,60
ERC25130T	13	27,60
ERC25140T	14	27,60
ERC25150T	15	27,60
ERC25160T	16	27,60

**ERC 25 SPANNZANGENSATZ ABGEDICHTET KLASSE 2**

Bestell-Nr. order no.	Inhalt content	Euro
ERC25SET2	14 Stück ERC 25 Spannanzgen abgedichtet Klasse 2, Ø 3-16 mm, 1,0 mm steigend, in Plastikkoffer 14 pcs ERC 25 coolant sealed collets class 2, Ø 3-16 mm in 1.0 mm steps, in plastic case	219,00

**ERC 25 SPANNZANGENSATZ ABGEDICHTET KLASSE 1**

Bestell-Nr. order no.	Inhalt content	Euro
ERC25SET1	14 Stück ERC 25 Spannanzgen abgedichtet Klasse 1, Ø 3-16 mm, 1,0 mm steigend, in Plastikkoffer 14 pcs ERC 25 coolant sealed collets class 1, Ø 3-16 mm in 1.0 mm steps, in plastic case	246,00

**ERC 25 SPANNZANGENSATZ ABGEDICHTET TOPAC**

Bestell-Nr. order no.	Inhalt content	Euro
ERC25SETT	14 Stück ERC 25 Spannanzgen abgedichtet TOPAC, Ø 3-16 mm, 1,0 mm steigend, in Plastikkoffer 14 pcs ERC 25 coolant sealed collets TOPAC, Ø 3-16 mm in 1.0 mm steps, in plastic case	299,00



## ER-SPANNZANGEN ABGEDICHTET (Für Innenkühlung)

coolant sealed ER collets (for internal coolant)

Pat. Nr. 2013/00719

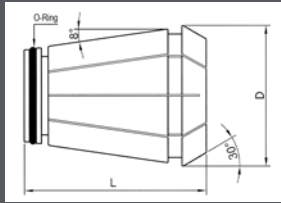

### ERC 32 SPANNZANGEN ABGEDICHTET

ERC 32 coolant sealed collets

D = 40 / L = 33

#### ERC 32 KLASSE 2

Bestell-Nr. order no.	Spann-Ø clamping Ø	Euro
ERC320302	3	21,20
ERC320402	4	21,20
ERC320502	5	21,20
ERC320602	6	21,20
ERC320702	7	21,20
ERC320802	8	21,20
ERC320902	9	21,20
ERC321002	10	21,20
ERC321102	11	21,20
ERC321202	12	21,20
ERC321302	13	21,20
ERC321402	14	21,20
ERC321502	15	21,20
ERC321602	16	21,20
ERC321702	17	21,20
ERC321802	18	21,20
ERC321902	19	21,20
ERC322002	20	21,20

#### ERC 32 KLASSE 1

Bestell-Nr. order no.	Spann-Ø clamping Ø	Euro
ERC320301	3	24,00
ERC320401	4	24,00
ERC320501	5	24,00
ERC320601	6	24,00
ERC320701	7	24,00
ERC320801	8	24,00
ERC320901	9	24,00
ERC321001	10	24,00
ERC321101	11	24,00
ERC321201	12	24,00
ERC321301	13	24,00
ERC321401	14	24,00
ERC321501	15	24,00
ERC321601	16	24,00
ERC321701	17	24,00
ERC321801	18	24,00
ERC321901	19	24,00
ERC322001	20	24,00

#### ERC 32 TOPAC (5 µ)

Bestell-Nr. order no.	Spann-Ø clamping Ø	Euro
ERC32030T	3	29,00
ERC32040T	4	29,00
ERC32050T	5	29,00
ERC32060T	6	29,00
ERC32070T	7	29,00
ERC32080T	8	29,00
ERC32090T	9	29,00
ERC32100T	10	29,00
ERC32110T	11	29,00
ERC32120T	12	29,00
ERC32130T	13	29,00
ERC32140T	14	29,00
ERC32150T	15	29,00
ERC32160T	16	29,00
ERC32170T	17	29,00
ERC32180T	18	29,00
ERC32190T	19	29,00
ERC32200T	20	29,00

### ERC 32 SPANNZANGENSÄTZE ABGEDICHTET

ERC 32 coolant sealed collet sets

#### ERC 32 SPANNZANGENSATZ ABGEDICHTET KLASSE 2

Bestell-Nr. order no.	Inhalt content	Euro
ERC32SET2	18 Stück ERC 32 Spannanzangen abgedichtet Klasse 2, Ø 3-20 mm, 1,0 mm steigend, in Plastikkoffer 18 pcs ERC 32 coolant sealed collets class 2, Ø 3-20 mm in 1.0 mm steps, in plastic case	297,00

#### ERC 32 SPANNZANGENSATZ ABGEDICHTET KLASSE 1

Bestell-Nr. order no.	Inhalt content	Euro
ERC32SET1	18 Stück ERC 32 Spannanzangen abgedichtet Klasse 1, Ø 3-20 mm, 1,0 mm steigend, in Plastikkoffer 18 pcs ERC 32 coolant sealed collets class 1, Ø 3-20 mm in 1.0 mm steps, in plastic case	335,00

#### ERC 32 SPANNZANGENSATZ ABGEDICHTET TOPAC

Bestell-Nr. order no.	Inhalt content	Euro
ERC32SETT	18 Stück ERC 32 Spannanzangen abgedichtet TOPAC, Ø 3-20 mm, 1,0 mm steigend, in Plastikkoffer 18 pcs ERC 32 coolant sealed collets TOPAC, Ø 3-20 mm in 1.0 mm steps, in plastic case	402,00

## ER-SPANNZANGEN ABGEDICHTET (Für Innenkühlung)

Coolant sealed ER collets (For internal coolant tools)

Pat. Nr. 2013/00719

### ERC 40 SPANNZANGEN ABGEDICHTET

ERC 40 coolant sealed collets

D = 41 / L = 46

ERC 40 KLASSE 2			ERC 40 KLASSE 1			ERC 40 TOPAC (5 µ)		
Bestell-Nr. order no.	Spann-Ø clamping Ø	Euro	Bestell-Nr. order no.	Spann-Ø clamping Ø	Euro	Bestell-Nr. order no.	Spann-Ø clamping Ø	Euro
ERC400302	3	25,20	ERC400301	3	28,00	ERC40030T	3	33,00
ERC400402	4	25,20	ERC400401	4	28,00	ERC40040T	4	33,00
ERC400502	5	25,20	ERC400501	5	28,00	ERC40050T	5	33,00
ERC400602	6	25,20	ERC400601	6	28,00	ERC40060T	6	33,00
ERC400702	7	25,20	ERC400701	7	28,00	ERC40070T	7	33,00
ERC400802	8	25,20	ERC400801	8	28,00	ERC40080T	8	33,00
ERC400902	9	25,20	ERC400901	9	28,00	ERC40090T	9	33,00
ERC401002	10	25,20	ERC401001	10	28,00	ERC40100T	10	33,00
ERC401102	11	25,20	ERC401101	11	28,00	ERC40110T	11	33,00
ERC401202	12	25,20	ERC401201	12	28,00	ERC40120T	12	33,00
ERC401302	13	25,20	ERC401301	13	28,00	ERC40130T	13	33,00
ERC401402	14	25,20	ERC401401	14	28,00	ERC40140T	14	33,00
ERC401502	15	25,20	ERC401501	15	28,00	ERC40150T	15	33,00
ERC401602	16	25,20	ERC401601	16	28,00	ERC40160T	16	33,00
ERC401702	17	25,20	ERC401701	17	28,00	ERC40170T	17	33,00
ERC401802	18	25,20	ERC401801	18	28,00	ERC40180T	18	33,00
ERC401902	19	25,20	ERC401901	19	28,00	ERC40190T	19	33,00
ERC402002	20	25,20	ERC402001	20	28,00	ERC40200T	20	33,00
ERC402102	21*	25,20	ERC402101	21*	28,00	ERC40210T	21*	33,00
ERC402202	22*	25,20	ERC402201	22*	28,00	ERC40220T	22*	33,00
ERC402302	23*	25,20	ERC402301	23*	28,00	ERC40230T	23*	33,00
ERC402402	24*	25,20	ERC402401	24*	28,00	ERC40240T	24*	33,00
ERC402502	25	25,20	ERC402501	25	28,00	ERC40250T	25	33,00
ERC402602	26*	25,20	ERC402601	26*	28,00	ERC40260T	26*	33,00

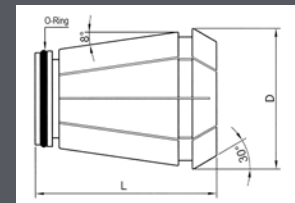
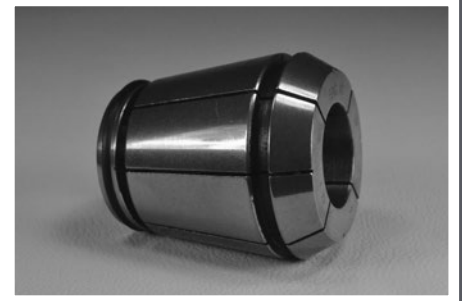

\* Diese Abmessungen sind nicht im ERC 40 Spannanzangensatz enthalten.

\* These sizes are not included in the ERC 40 set.

### ERC 40 SPANNZANGENSATZ ABGEDICHTET

ERC 40 coolant sealed collet sets

ERC 40 SPANNZANGENSATZ ABGEDICHTET KLASSE 2		
Bestell-Nr. order no.	Inhalt content	Euro
ERC40SET2	19 Stück ERC 40 Spannanzangen abgedichtet Klasse 2, Ø 3-25 mm, in Plastikkoffer 19 pcs ERC 40 coolant sealed collets class 2, Ø 3-25 mm, in plastic case	378,00

ERC 40 SPANNZANGENSATZ ABGEDICHTET KLASSE 1		
Bestell-Nr. order no.	Inhalt content	Euro
ERC40SET1	19 Stück ERC 40 Spannanzangen abgedichtet Klasse 1, Ø 3-25 mm, in Plastikkoffer 19 pcs ERC 40 coolant sealed collets class 1, Ø 3-25 mm, in plastic case	418,00

ERC 40 SPANNZANGENSATZ ABGEDICHTET TOPAC		
Bestell-Nr. order no.	Inhalt content	Euro
ERC40SETT	19 Stück ERC 40 Spannanzangen abgedichtet TOPAC, Ø 3-25 mm, in Plastikkoffer 19 pcs ERC 40 coolant sealed collets TOPAC, Ø 3-25 mm, in plastic case	489,00

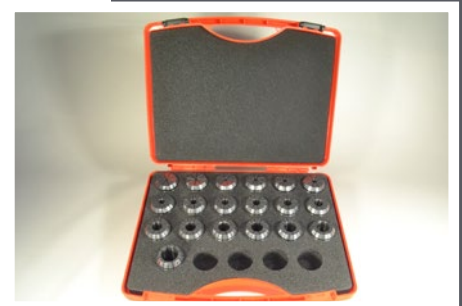

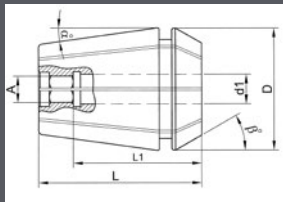
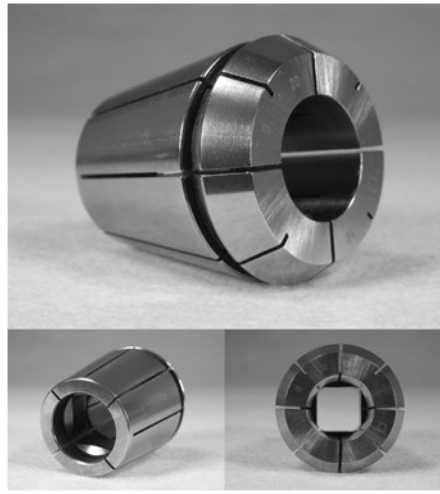

\* Zeigt nur einige geeignete Beispiele.

Alle ER-Spannzangen mit Vierkantmitnahme haben eine Rundlaufgenauigkeit von max. 10 µ (Klasse 1).

\* Indicates only some suitable sizes.

Tapping ER collets are all made to 10 micron run-out accuracy (class 1).

## ER-SPANNZANGEN MIT VIERKANTMITNAHME

tapping ER collets

### ERT 16 SPANNZANGEN MIT VIERKANTMITNAHME

D = 16.5 / L = 27.5

ERT 16 tapping collets

Bestell-Nr. order no.	d1	A – Vierkantaufnahme □ mm A – tap square size □ mm	Spezifikation Gewindebohrer* tap specification*	Euro
ERT16028	2.8	2.1	DIN371 M2-M2.5 - DIN376 M4	22,00
ERT16035	3.5	2.7	DIN371 M3 - DIN376 M5	22,00
ERT16040	4	3.15/3.2	ISO M4/M5 - JIS M3/M3.5	22,00
ERT16045	4.5	3.4	DIN371 M4 - DIN376 M6	22,00
ERT16050	5	4	ISO M5 - JIS M4	22,00
ERT16055	5.5	4.3	DIN374/376 M7	22,00
ERT16060	6	4.9	DIN371 M4.5/M5/M6 DIN374/376 M8	22,00
ERT16063	6.3	5	ISO M6-M8-1/4"-5/16"	22,00
ERT16070	7	5.5	DIN371 M7 DIN374/376 M9-M10 JIS M9-M10	22,00
ERT16080	8	6.2/6.3	DIN371 M8 ISO M8 - M10 - 7/16" - 5/16"	22,00

### ERT 16 SPANNZANGENSATZ MIT VIERKANTMITNAHME

ERT 16 tapping collet set

Bestell-Nr. order no.	Inhalt content	Euro
ERT16SET	10 Stück ERT 16 Spannzangen mit Vierkantmitnahme, geeignet für Gewindebohrer mit Aufnahmen Ø 2.8-8.0 mm, in Plastikkoffer 10 pcs ERT 16 tapping ER collets, suitable for taps with shank Ø 2.8-8.0 mm, in plastic case	169,00

### ERT 20 SPANNZANGEN MIT VIERKANTMITNAHME

D = 20.5 / L = 32.5

ERT 20 tapping collets

Bestell-Nr. order no.	d1	A – Vierkantaufnahme □ mm A – tap square size □ mm	Spezifikation Gewindebohrer* tap specification*	Euro
ERT20035	3.5	2.7	DIN371 M3 - DIN376 M5	22,40
ERT20040	4	3.15/3.2	ISO M4/M5 - JIS M3/M3.5	22,40
ERT20045	4.5	3.4	DIN371 M4 - DIN376 M6	22,40
ERT20050	5	4	ISO M5 - JIS M4	22,40
ERT20055	5.5	4.3	DIN374/376 M7	22,40
ERT20060	6	4.9	DIN371 M4.5/M5/M6 DIN374/376 M8	22,40
ERT20063	6.3	5	ISO M6-M8-1/4"-5/16"	22,40
ERT20070	7	5.5	DIN371 M7 DIN374/376 M9-M10 JIS M9-M10	22,40
ERT20080	8	6.2/6.3	DIN371 M8 ISO M8 - M10 - 7/16" - 5/16"	22,40
ERT20090	9	7.0/7.1	DIN 374/376 M12 ISO M12 - 1/2"	22,40
ERT20100	10	8	DIN371 M10 ISO M10 - 3/8"	22,40
ERT20110	11	9	DIN 374/376 M14 - 9/16"	22,40
ERT20120	12	9	DIN 374/376 M16 - 5/8"	22,40

### ERT 20 SPANNZANGENSATZ MIT VIERKANTMITNAHME

ERT 20 tapping collet set

Bestell-Nr. order no.	Inhalt content	Euro
ERT20SET	13 Stück ERT 20 Spannzangen mit Vierkantmitnahme, geeignet für Gewindebohrer mit Aufnahmen Ø 3.5-12.0 mm, in Plastikkoffer 13 pcs ERT 20 tapping ER collets, suitable for taps with shank Ø 3.5-12.0 mm, in plastic case	224,00

## ER-SPANNZANGEN MIT VIERKANTMITNAHME

tapping ER collets

### ERT 25 SPANNZANGEN MIT VIERKANTMITNAHME

D = 25.5 / L = 34

ERT 25 tapping collets

Bestell-Nr. order no.	d1	A – Vierkantaufnahme □ mm A – tap square size □ mm	Spezifikation Gewindebohrer* tap specification*	Euro
ERT25035	3.5	2.7	DIN371 M3 - DIN376 M5	23,00
ERT25040	4	3.15/3.2	ISO M4/M5 - JIS M3/M3.5	23,00
ERT25045	4.5	3.4	DIN371 M4 - DIN376 M6	23,00
ERT25050	5	4	ISO M5 - JIS M4	23,00
ERT25055	5.5	4.3	DIN374/376 M7	23,00
ERT25060	6	4.9	DIN371 M4.5/M5/M6 DIN374/376 M8	23,00
ERT25063	6.3	5	ISO M6-M8-1/4"-5/16"	23,00
ERT25070	7	5.5	DIN371 M7 DIN374/376 M9-M10 JIS M9-M10	23,00
ERT25080	8	6.2/6.3	DIN371 M8 ISO M8 - M10 - 7/16" - 5/16"	23,00
ERT25090	9	7.0/7.1	DIN 374/376 M12 ISO M12 - 1/2"	23,00
ERT25100	10	8	DIN371 M10 ISO M10 - 3/8"	23,00
ERT25110	11	9	DIN 374/376 M14 - 9/16"	23,00
ERT25120	12	9	DIN 374/376 M16 - 5/8"	23,00
ERT25125*	12.5	10	ISO M16 - 5/8" JIS M16	23,00
ERT25140	14	11.0/11.2	DIN 374/376 M18 - JIS M18 ISO M18/M20 3/4"	23,00
ERT25160	16	12	DIN 374/376 M20	23,00

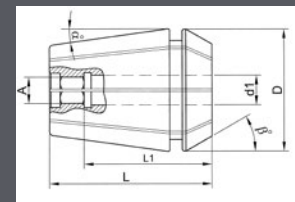
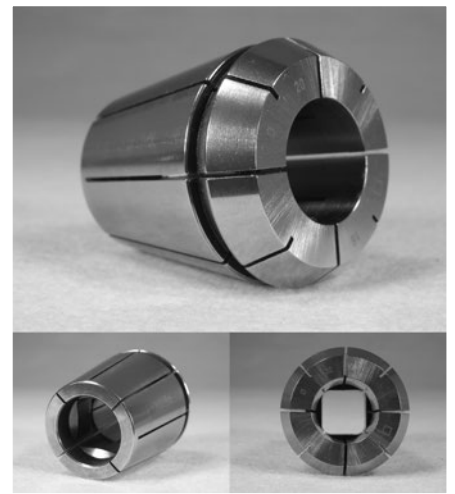

### ERT 25 SPANNZANGENSATZ MIT VIERKANTMITNAHME

ERT 25 tapping collet set

Bestell-Nr. order no.	Inhalt content	Euro
ERT25SET	15 Stück ERT 25 Spannanzangen mit Vierkantmitnahme, geeignet für Gewindebohrer mit Aufnahmen Ø 3.5-16.0, in Plastikbox 15 pcs ERT 25 tapping ER collets, suitable for taps with shank Ø 3.5-16.0, in plastic case	268,00

\* Bitte beachten Sie, dass diese Abmessungen nicht im Satz enthalten sind.

\* Please note these items are not included in the set.

### ERT 32 SPANNZANGEN MIT VIERKANTMITNAHME

D = 32.5 / L = 40

ERT 32 tapping collets

Bestell-Nr. order no.	d1	A – Vierkantaufnahme □ mm A – tap square size □ mm	Spezifikation Gewindebohrer* tap specification*	Euro
ERT32035	3.5	2.7	DIN371 M3 - DIN376 M5	25,20
ERT32040	4	3.15/3.2	ISO M4/M5 - JIS M3/M3.5	25,20
ERT32045	4.5	3.4	DIN371 M4 - DIN376 M6	25,20
ERT32050	5	4	ISO M5 - JIS M4	25,20
ERT32055	5.5	4.3	DIN374/376 M7	25,20
ERT32060	6	4.9	DIN371 M4.5/M5/M6 DIN374/376 M8	25,20
ERT32063	6.3	5	ISO M6-M8-1/4"-5/16"	25,20
ERT32070	7	5.5	DIN371 M7 DIN374/376 M9-M10 JIS M9-M10	25,20
ERT32080	8	6.2/6.3	DIN371 M8 ISO M8 - M10 - 7/16" - 5/16"	25,20
ERT32090	9	7.0/7.1	DIN 374/376 M12 ISO M12 - 1/2"	25,20
ERT32100	10	8	DIN371 M10 ISO M10 - 3/8"	25,20
ERT32110	11	9	DIN 374/376 M14 - 9/16"	25,20
ERT32120	12	9	DIN 374/376 M16 - 5/8"	25,20
ERT32125	12.5	10	ISO M16 - 5/8" JIS M16	25,20
ERT32140	14	11.0/11.2	DIN 374/376 M18 - JIS M18 ISO M18-M20 3/4"	25,20
ERT32160	16	12	DIN 374/376 M20	25,20
ERT32180	18	14.0/14.5	DIN 374/376 M22- M24 -7/8" ISO M24 - 1"	25,20
ERT32200	20	16	DIN 374/376 M27 - 1" ISO M27-M30 - 1 1/8"	25,20

### ERT 32 SPANNZANGENSATZ MIT VIERKANTMITNAHME

ERT 32 tapping collet set

Bestell-Nr.	Inhalt / content	Euro
ERT32SET	18 Stück ERT 32 Spannanzangen mit Vierkantmitnahme, geeignet für Gewindebohrer mit Aufnahmen Ø 3.5-20.0 mm, in Plastikbox 18 pcs ERT 32 tapping ER collets, suitable for taps with shank Ø 3.5-20.0 mm, in plastic case	351,00

## ER-SPANNZANGEN MIT VIERKANTMITNAHME

tapping ER collets

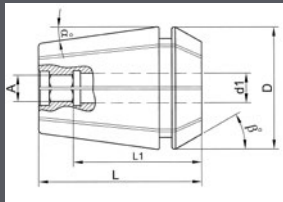
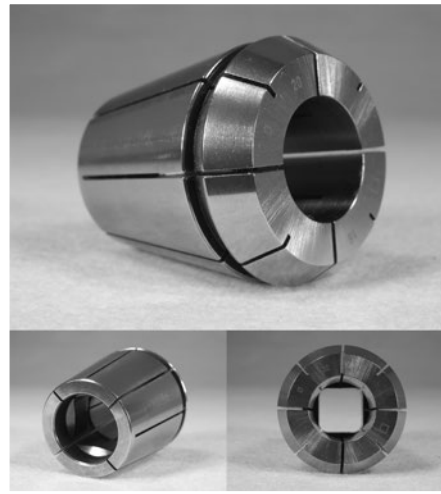

\* Zeigt nur einige geeignete Beispiele.

Alle ER-Spannzangen mit Vierkantmitnahme haben eine Rundlaufgenauigkeit von max. 10  $\mu$  (Klasse 1).

\*\* Bitte beachten Sie, dass diese Abmessung nicht im Satz enthalten ist.

\* Indicates only some suitable sizes.

Tapping ER collets are all made to 10 micron run-out accuracy (class 1).

\*\* Please note this item is not included in the set.

### ERT 40 SPANNZANGEN MIT VIERKANTMITNAHME

ERT 40 tapping collets

D = 40.5 / L = 46

Bestell-Nr. order no.	d1	A – Vierkantaufnahme □ mm A – tap square size □ mm	Spezifikation Gewindebohrer* tap specification*	Euro
ERT40040	4	3.15/3.2	ISO M4/M5 - JIS M3/M3.5	28,80
ERT40045	4.5	3.4	DIN371 M4 - DIN376 M6	28,80
ERT40050	5	4	ISO M5 - JIS M4	28,80
ERT40055	5.5	4.3	DIN374/376 M7	28,80
ERT40060	6	4.9	DIN371 M4.5/M5/M6 DIN374/376 M8	28,80
ERT40063	6.3	5	ISO M6-M8-1/4"-5/16"	28,80
ERT40070	7	5.5	DIN371 M7 DIN374/376 M9-M10 JIS M9-M10	28,80
ERT40080	8	6.2/6.3	DIN371 M8 ISO M8 - M10 - 7/16" - 5/16"	28,80
ERT40090	9	7.0/7.1	DIN 374/376 M12 ISO M12 - 1/2"	28,80
ERT40100	10	8	DIN371 M10 ISO M10 - 3/8"	28,80
ERT40110	11	9	DIN 374/376 M14 - 9/16"	28,80
ERT40120	12	9	DIN 374/376 M16 - 5/8"	28,80
ERT40125	12.5	10	ISO M16 - 5/8" JIS M16	28,80
ERT40140	14	11.0/11.2	DIN 374/376 M18 - JIS M18 ISO M18-M20 3/4"	28,80
ERT40160	16	12	DIN 374/376 M20	28,80
ERT40170**	17	13	JIS M22 7/8"	28,80
ERT40180	18	14.0/14.5	DIN 374/376 M22- M24 -7/8" ISO M24 - 1"	28,80
ERT40200	20	16	DIN 374/376 M27 - 1" ISO M27-M30 - 1 1/8"	28,80
ERT40220	22	18	DIN 374/376 M30 - 1 1/8"	28,80
ERT40250	25	20	DIN 374/376 M33 - 1 1/4" ISO M36	28,80

### ERT 40 SPANNZANGENSATZ MIT VIERKANTMITNAHME

ERT 40 tapping collet set

Bestell-Nr. order no.	Inhalt content	Euro
ERT40SET	19 Stück ERT 40 Spannzangen mit Vierkantmitnahme, geeignet für Gewindebohrer mit Aufnahmen Ø 4,0-25,0, in Plastikkoffer 19 pcs ERT 40 tapping ER collets, suitable for taps with shank Ø 4.0-25.0, in plastic case	429,00



## ER-SPANNZANGEN ZOLLABMESSUNGEN

inch sized ER collets

ER 8	KLASSE 2		KLASSE 1		TOPAC (5 μ)	
	Bestell-Nr. order no.	Euro	Bestell-Nr. order no.	Euro	Bestell-Nr. order no.	Euro
Spann-Ø Zoll clamping Ø inch						
1/16"	ER0801592	14,80	ER0801591	17,60	ER080159T	25,60
1/8"	ER0803182	10,20	ER0803181	12,40	ER080318T	16,80
3/16"	ER0804762	10,20	ER0804761	12,40	ER080476T	16,80

ER 11	KLASSE 2		KLASSE 1		TOPAC (5 μ)	
	Bestell-Nr. order no.	Euro	Bestell-Nr. order no.	Euro	Bestell-Nr. order no.	Euro
Spann-Ø Zoll clamping Ø inch						
1/16"	ER1101592	13,80	ER1101591	16,20	ER110159T	24,20
1/8"	ER1103182	9,00	ER1103181	11,00	ER110318T	15,40
3/16"	ER1104762	9,00	ER1104761	11,00	ER110476T	15,40
1/4"	ER1106352	9,00	ER1106351	11,00	ER110635T	15,40

ER 16	KLASSE 2		KLASSE 1		TOPAC (5 μ)	
	Bestell-Nr. order no.	Euro	Bestell-Nr. order no.	Euro	Bestell-Nr. order no.	Euro
Spann-Ø Zoll clamping Ø inch						
1/16"	ER1601592	11,00	ER1601591	14,40	ER160159T	22,00
1/8"	ER1603182	7,20	ER1603181	9,80	ER160318T	13,60
3/16"	ER1604762	7,20	ER1604761	9,80	ER160476T	13,60
1/4"	ER1606352	7,20	ER1606351	9,80	ER160635T	13,60
5/16"	ER1607942	7,20	ER1607941	9,80	ER160794T	13,60
3/8"	ER1609532	7,20	ER1609531	9,80	ER160953T	13,60

ER 20	KLASSE 2		KLASSE 1		TOPAC (5 μ)	
	Bestell-Nr. order no.	Euro	Bestell-Nr. order no.	Euro	Bestell-Nr. order no.	Euro
Spann-Ø Zoll clamping Ø inch						
1/16"	ER2001592	11,60	ER2001591	15,00	ER200159T	22,60
1/8"	ER2003182	7,60	ER2003181	10,40	ER200318T	14,00
3/16"	ER2004762	7,60	ER2004761	10,40	ER200476T	14,00
1/4"	ER2006352	7,60	ER2006351	10,40	ER200635T	14,00
5/16"	ER2007942	7,60	ER2007941	10,40	ER200794T	14,00
3/8"	ER2009532	7,60	ER2009531	10,40	ER200953T	14,00
7/16"	ER2011112	7,60	ER2011111	10,40	ER201111T	14,00
1/2"	ER2012702	7,60	ER2012701	10,40	ER201270T	14,00

ER 25	KLASSE 2		KLASSE 1		TOPAC (5 μ)	
	Bestell-Nr. order no.	Euro	Bestell-Nr. order no.	Euro	Bestell-Nr. order no.	Euro
Spann-Ø Zoll clamping Ø inch						
1/16"	ER2501592	13,60	ER2501591	17,00	ER250159T	24,60
1/8"	ER2503182	8,20	ER2503181	11,00	ER250318T	14,60
3/16"	ER2504762	8,20	ER2504761	11,00	ER250476T	14,60
1/4"	ER2506352	8,20	ER2506351	11,00	ER250635T	14,60
5/16"	ER2507942	8,20	ER2507941	11,00	ER250794T	14,60
3/8"	ER2509532	8,20	ER2509531	11,00	ER250953T	14,60
7/16"	ER2511112	8,20	ER2511111	11,00	ER251111T	14,60
1/2"	ER2512702	8,20	ER2512701	11,00	ER251270T	14,60
9/16"	ER2514292	8,20	ER2514291	11,00	ER251429T	14,60
5/8"	ER2515882	8,20	ER2515881	11,00	ER251588T	14,60

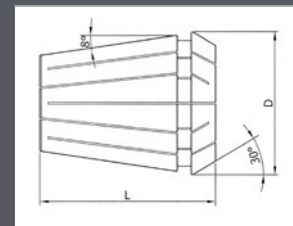
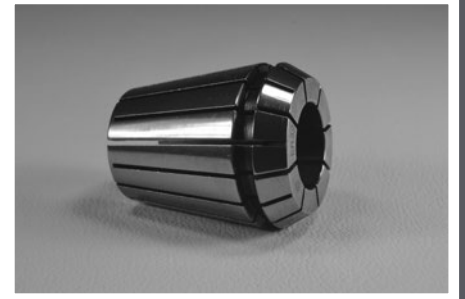

Weitere Abmessungen auf Anfrage.

Other inch sized collets are available on request.

## ER-SPANNZANGEN ZOLLABMESSUNGEN

inch sized ER collets

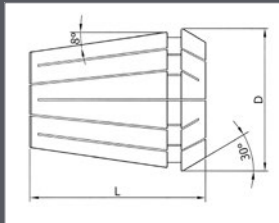
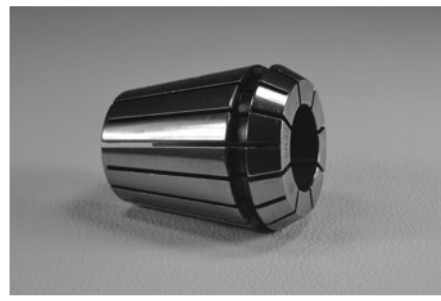

Weitere Abmessungen auf Anfrage.

Other inch sized collets are available on request.

ER 32	KLASSE 2		KLASSE 1		TOPAC (5 μ)	
	Spann-Ø Zoll clamping Ø inch	Bestell-Nr. order no.	Euro	Bestell-Nr. order no.	Euro	Bestell-Nr. order no.
1/8"	ER3203182	8,60	ER3203181	11,80	ER320318T	15,20
3/16"	ER3204762	8,60	ER3204761	11,80	ER320476T	15,20
1/4"	ER3206352	8,60	ER3206351	11,80	ER320635T	15,20
5/16"	ER3207942	8,60	ER3207941	11,80	ER320794T	15,20
3/8"	ER3209532	8,60	ER3209531	11,80	ER320953T	15,20
7/16"	ER3211112	8,60	ER3211111	11,80	ER321111T	15,20
1/2"	ER3212702	8,60	ER3212701	11,80	ER321270T	15,20
9/16"	ER3214292	8,60	ER3214291	11,80	ER321429T	15,20
5/8"	ER3215882	8,60	ER3215881	11,80	ER321588T	15,20
11/16"	ER3217462	8,60	ER3217461	11,80	ER321746T	15,20
3/4"	ER3219052	8,60	ER3219051	11,80	ER321905T	15,20

ER 40	KLASSE 2		KLASSE 1		TOPAC (5 μ)	
	Spann-Ø Zoll clamping Ø inch	Bestell-Nr. order no.	Euro	Bestell-Nr. order no.	Euro	Bestell-Nr. order no.
1/8"	ER4003182	14,80	ER4003181	17,80	ER400318T	21,60
5/32"	ER4003972	10,60	ER4003971	14,40	ER400397T	18,20
3/16"	ER4004762	10,60	ER4004761	14,40	ER400476T	18,20
7/32"	ER4005562	10,60	ER4005561	14,40	ER400556T	18,20
1/4"	ER4006352	10,60	ER4006351	14,40	ER400635T	18,20
9/32"	ER4007142	10,60	ER4007141	14,40	ER400714T	18,20
5/16"	ER4007942	10,60	ER4007941	14,40	ER400794T	18,20
11/32"	ER4008732	10,60	ER4008731	14,40	ER400873T	18,20
3/8"	ER4009532	10,60	ER4009531	14,40	ER400953T	18,20
13/32"	ER4010322	10,60	ER4010321	14,40	ER401032T	18,20
7/16"	ER4011112	10,60	ER4011111	14,40	ER401111T	18,20
15/32"	ER4011912	10,60	ER4011911	14,40	ER401191T	18,20
1/2"	ER4012702	10,60	ER4012701	14,40	ER401270T	18,20
17/32"	ER4013492	10,60	ER4013491	14,40	ER401349T	18,20
9/16"	ER4014292	10,60	ER4014291	14,40	ER401429T	18,20
19/32"	ER4015082	10,60	ER4015081	14,40	ER401508T	18,20
5/8"	ER4015882	10,60	ER4015881	14,40	ER401588T	18,20
21/32"	ER4016672	10,60	ER4016671	14,40	ER401667T	18,20
11/16"	ER4017462	10,60	ER4017461	14,40	ER401746T	18,20
23/32"	ER4018262	10,60	ER4018261	14,40	ER401826T	18,20
3/4"	ER4019052	10,60	ER4019051	14,40	ER401905T	18,20
13/16"	ER4020642	10,60	ER4020641	14,40	ER402064T	18,20
7/8"	ER4022232	10,60	ER4022231	14,40	ER402223T	18,20
15/16"	ER4023812	10,60	ER4023811	14,40	ER402381T	18,20
1"	ER4025402	10,60	ER4025401	14,40	ER402540T	18,20

## ER-SPANNZANGEN ABGEDICHTET ZOLLABMESSUNGEN

für Innenkühlung

inch sized coolant sealed ER collets for internal coolant tools

Pat. Nr. 2013/00719

ERC 16	KLASSE 2		KLASSE 1		TOPAC (5 µ)	
	Bestell-Nr. order no.	Euro	Bestell-Nr. order no.	Euro	Bestell-Nr. order no.	Euro
Spann-Ø Zoll clamping Ø inch						
1/4"	ERC1606352	20,80	ERC1606351	23,40	ERC160635T	28,40
5/16"	ERC1607942	20,80	ERC1607941	23,40	ERC160794T	28,40
3/8"	ERC1609532	20,80	ERC1609531	23,40	ERC160953T	28,40

ERC 20	KLASSE 2		KLASSE 1		TOPAC (5 µ)	
	Bestell-Nr. order no.	Euro	Bestell-Nr. order no.	Euro	Bestell-Nr. order no.	Euro
Spann-Ø Zoll clamping Ø inch						
1/4"	ERC2006352	21,00	ERC2006351	23,60	ERC200635T	28,60
5/16"	ERC2007942	21,00	ERC2007941	23,60	ERC200794T	28,60
3/8"	ERC2009532	21,00	ERC2009531	23,60	ERC200953T	28,60
7/16"	ERC2011112	21,00	ERC2011111	23,60	ERC201111T	28,60

ERC 25	KLASSE 2		KLASSE 1		TOPAC (5 µ)	
	Bestell-Nr. order no.	Euro	Bestell-Nr. order no.	Euro	Bestell-Nr. order no.	Euro
Spann-Ø Zoll clamping Ø inch						
1/4"	ERC2506352	22,20	ERC2506351	24,80	ERC250635T	29,80
5/16"	ERC2507942	22,20	ERC2507941	24,80	ERC250794T	29,80
3/8"	ERC2509532	22,20	ERC2509531	24,80	ERC250953T	29,80
7/16"	ERC2511112	22,20	ERC2511111	24,80	ERC251111T	29,80
1/2"	ERC2512702	22,20	ERC2512701	24,80	ERC251270T	29,80
9/16"	ERC2514292	22,20	ERC2514291	24,80	ERC251429T	29,80
5/8"	ERC2515882	22,20	ERC2515881	24,80	ERC251588T	29,80

ERC 32	KLASSE 2		KLASSE 1		TOPAC (5 µ)	
	Bestell-Nr. order no.	Euro	Bestell-Nr. order no.	Euro	Bestell-Nr. order no.	Euro
Spann-Ø Zoll clamping Ø inch						
1/4"	ERC3206352	23,20	ERC3206351	26,00	ERC320635T	31,00
5/16"	ERC3207942	23,20	ERC3207941	26,00	ERC320794T	31,00
3/8"	ERC3209532	23,20	ERC3209531	26,00	ERC320953T	31,00
7/16"	ERC3211112	23,20	ERC3211111	26,00	ERC321111T	31,00
1/2"	ERC3212702	23,20	ERC3212701	26,00	ERC321270T	31,00
9/16"	ERC3214292	23,20	ERC3214291	26,00	ERC321429T	31,00
5/8"	ERC3215882	23,20	ERC3215881	26,00	ERC321588T	31,00
3/4"	ERC3219052	23,20	ERC3219051	26,00	ERC321905T	31,00

ERC 40	KLASSE 2		KLASSE 1		TOPAC (5 µ)	
	Bestell-Nr. order no.	Euro	Bestell-Nr. order no.	Euro	Bestell-Nr. order no.	Euro
Spann-Ø Zoll clamping Ø inch						
1/4"	ERC4006352	27,20	ERC4006351	30,00	ERC400635T	35,00
5/16"	ERC4007942	27,20	ERC4007941	30,00	ERC400794T	35,00
3/8"	ERC4009532	27,20	ERC4009531	30,00	ERC400953T	35,00
7/16"	ERC4011112	27,20	ERC4011111	30,00	ERC401111T	35,00
1/2"	ERC4012702	27,20	ERC4012701	30,00	ERC401270T	35,00
9/16"	ERC4014292	27,20	ERC4014291	30,00	ERC401429T	35,00
5/8"	ERC4015882	27,20	ERC4015881	30,00	ERC401588T	35,00
3/4"	ERC4019052	27,20	ERC4019051	30,00	ERC401905T	35,00
1"	ERC4025402	27,20	ERC4025401	30,00	ERC402540T	35,00

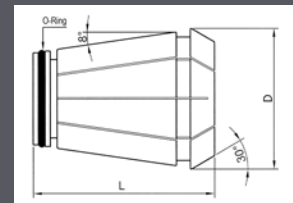
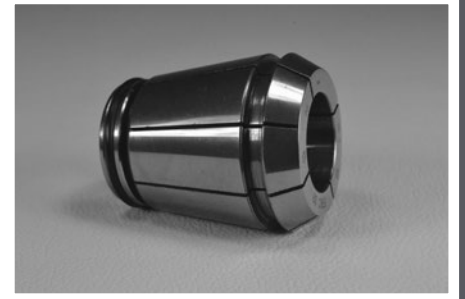

### EIGENSCHAFTEN ERC SPANNZANGEN ABGEDICHTET

Innenkühlung nur unter Spannung der Zange.

Der Schaft des Werkzeugs muss bis ans Ende der abgedichteten Spann- zange eingeführt werden (siehe Anweisung).

Geeignet für alle ER-Spannzangen- aufnahmen.

Kann auch als Standard ER-Spann- zange ohne Innenkühlung eingesetzt werden.

Weniger flexibel mit härterer Struktur im Gegensatz zu Standard ER- Spann- zangen.

Weitere Abmessungen auf Anfrage.

### Features of coolant sealed ER collets

Coolant Sealed performance only when clamped the nominal diameter.

The shank should be inserted till the back end of the collet as shown in the instruction.

Suitable for all kinds of ER collet holders.

May also be used as standard ER collet for the nominal diameter cutters without internal coolant.

Less flexible with harder structure compared with standard ER collets.

Other sizes are available on request.

## ORTLIEB SPANNZANGEN OZ 25 DIN6388B ORTLIEB OZ 25 collets

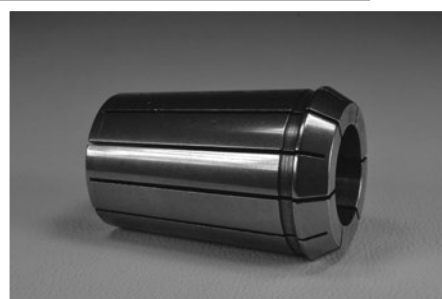

D	35.05
L	52
$\alpha$	2° 52'
$\beta$	30
Spannbereich clamping range	2.0-25.4
steigend clamping steps	0.5

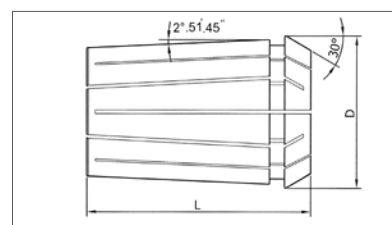

### OZ 25 KLASSE 2

Bestell-Nr. order no.	Spann-Ø clamping Ø	Euro
OZ250202	2.0-1.5	20,80
OZ250252	2.5-2.0	20,80
OZ250302	3.0-2.5	19,60
OZ250352	3.5-3.0	19,60
OZ250402	4.0-3.5	14,60
OZ250452	4.5-4.0	18,40
OZ250502	5.0-4.5	14,60
OZ250552	5.5-5.0	18,40
OZ250602	6.0-5.5	14,60
OZ250632	1/4" (6.35)	18,40
OZ250652	6.5-6.0	18,40
OZ250702	7.0-6.5	14,60
OZ250752	7.5-7.0	18,40
OZ250802	8.0-7.5	14,60
OZ250852	8.5-8.0	18,40
OZ250902	9.0-8.5	14,60
OZ250952	9.5-9.0	18,40
OZ250962	3/8" (9.53)	18,40
OZ251002	10.0-9.5	14,60
OZ251052	10.5-10.0	18,40
OZ251102	11.0-10.5	14,60
OZ251152	11.5-11.0	18,40
OZ251202	12.0-11.5	14,60
OZ251252	12.5-12.0	18,40
OZ251272	1/2" (12.70)	18,40
OZ251302	13.0-12.5	14,60
OZ251352	13.5-13.0	18,40
OZ251402	14.0-13.5	14,60
OZ251452	14.5-14.0	18,40
OZ251502	15.0-14.5	14,60
OZ251552	15.5-15.0	18,40
OZ251582	5/8" (15.87)	18,40
OZ251602	16.0-15.5	14,60
OZ251652	16.5-16.0	18,40
OZ251702	17.0-16.5	14,60
OZ251752	17.5-17.0	18,40
OZ251802	18.0-17.5	14,60
OZ251852	18.5-18.0	18,40
OZ251902	19.0-18.5	14,60
OZ251912	3/4" (19.05)	18,40
OZ251952	19.5-19.0	18,40
OZ252002	20.0-19.5	14,60
OZ252052	20.5-20.0	18,40
OZ252102	21.0-20.5	14,60
OZ252152	21.5-21.0	18,40
OZ252202	22.0-21.5	14,60
OZ252252	22.5-22.0	18,40
OZ252302	23.0-22.5	14,60
OZ252352	23.5-23.0	18,40
OZ252402	24.0-23.5	14,60
OZ252452	24.5-24.0	18,40
OZ252502	25.0-24.5	14,60
OZ252542	1" (25.40)	18,40

### OZ 25 KLASSE 1

Bestell-Nr. order no.	Spann-Ø clamping Ø	Euro
OZ250201	2.0-1.5	23,20
OZ250251	2.5-2.0	23,20
OZ250301	3.0-2.5	22,00
OZ250351	3.5-3.0	22,00
OZ250401	4.0-3.5	17,00
OZ250451	4.5-4.0	20,80
OZ250501	5.0-4.5	17,00
OZ250551	5.5-5.0	20,80
OZ250601	6.0-5.5	17,00
OZ250631	1/4" (6.35)	20,80
OZ250651	6.5-6.0	20,80
OZ250701	7.0-6.5	17,00
OZ250751	7.5-7.0	20,80
OZ250801	8.0-7.5	17,00
OZ250851	8.5-8.0	20,80
OZ250901	9.0-8.5	17,00
OZ250951	9.5-9.0	20,80
OZ250961	3/8" (9.53)	20,80
OZ251001	10.0-9.5	17,00
OZ251051	10.5-10.0	20,80
OZ251101	11.0-10.5	17,00
OZ251151	11.5-11.0	20,80
OZ251201	12.0-11.5	17,00
OZ251251	12.5-12.0	20,80
OZ251271	1/2" (12.70)	20,80
OZ251301	13.0-12.5	17,00
OZ251351	13.5-13.0	20,80
OZ251401	14.0-13.5	17,00
OZ251451	14.5-14.0	20,80
OZ251501	15.0-14.5	17,00
OZ251551	15.5-15.0	20,80
OZ251581	5/8" (15.87)	20,80
OZ251601	16.0-15.5	17,00
OZ251651	16.5-16.0	20,80
OZ251701	17.0-16.5	17,00
OZ251751	17.5-17.0	20,80
OZ251801	18.0-17.5	17,00
OZ251851	18.5-18.0	20,80
OZ251901	19.0-18.5	17,00
OZ251911	3/4" (19.05)	20,80
OZ251951	19.5-19.0	20,80
OZ252001	20.0-19.5	17,00
OZ252051	20.5-20.0	20,80
OZ252101	21.0-20.5	17,00
OZ252151	21.5-21.0	20,80
OZ252201	22.0-21.5	17,00
OZ252251	22.5-22.0	20,80
OZ252301	23.0-22.5	17,00
OZ252351	23.5-23.0	20,80
OZ252401	24.0-23.5	17,00
OZ252451	24.5-24.0	20,80
OZ252501	25.0-24.5	17,00
OZ252541	1" (25.40)	20,80

### OZ 25 TOPAC (5 µ)

Bestell-Nr. order no.	Spann-Ø clamping Ø	Euro
OZ25020T	2.0-1.5	27,20
OZ25025T	2.5-2.0	27,20
OZ25030T	3.0-2.5	26,00
OZ25035T	3.5-3.0	26,00
OZ25040T	4.0-3.5	21,00
OZ25045T	4.5-4.0	24,80
OZ25050T	5.0-4.5	21,00
OZ25055T	5.5-5.0	24,80
OZ25060T	6.0-5.5	21,00
OZ25063T	1/4" (6.35)	24,80
OZ25065T	6.5-6.0	24,80
OZ25070T	7.0-6.5	21,00
OZ25075T	7.5-7.0	24,80
OZ25080T	8.0-7.5	21,00
OZ25085T	8.5-8.0	24,80
OZ25090T	9.0-8.5	21,00
OZ25095T	9.5-9.0	24,80
OZ25096T	3/8" (9.53)	24,80
OZ25100T	10.0-9.5	21,00
OZ25105T	10.5-10.0	24,80
OZ25110T	11.0-10.5	21,00
OZ25115T	11.5-11.0	24,80
OZ25120T	12.0-11.5	21,00
OZ25125T	12.5-12.0	24,80
OZ25127T	1/2" (12.70)	24,80
OZ25130T	13.0-12.5	21,00
OZ25135T	13.5-13.0	24,80
OZ25140T	14.0-13.5	21,00
OZ25145T	14.5-14.0	24,80
OZ25150T	15.0-14.5	21,00
OZ25155T	15.5-15.0	24,80
OZ25158T	5/8" (15.87)	24,80
OZ25160T	16.0-15.5	21,00
OZ25165T	16.5-16.0	24,80
OZ25170T	17.0-16.5	21,00
OZ25175T	17.5-17.0	24,80
OZ25180T	18.0-17.5	21,00
OZ25185T	18.5-18.0	24,80
OZ25190T	19.0-18.5	21,00
OZ25191T	3/4" (19.05)	24,80
OZ25195T	19.5-19.0	24,80
OZ25200T	20.0-19.5	21,00
OZ25205T	20.5-20.0	24,80
OZ25210T	21.0-20.5	21,00
OZ25215T	21.5-21.0	24,80
OZ25220T	22.0-21.5	21,00
OZ25225T	22.5-22.0	24,80
OZ25230T	23.0-22.5	21,00
OZ25235T	23.5-23.0	24,80
OZ25240T	24.0-23.5	21,00
OZ25245T	24.5-24.0	24,80
OZ25250T	25.0-24.5	21,00
OZ25254T	1" (25.40)	24,80



## SPANNZANGENSÄTZE OZ 25 DIN6388B-25

## OZ 25 collet sets

### OZ 25 SPANNZANGENSATZ

Inhalt content
24 Stück OZ 25 Spannzangen, Ø 2-25 mm, 1 mm steigend, in Plastikofficer 24 pcs DIN6388B-25 collets, Ø 2-25 mm in 1 mm steps, in plastic case

### KLASSE 2

Bestell-Nr. order no.	Euro
OZ25SET2	293,00

### KLASSE 1

Bestell-Nr. order no.	Euro
OZ25SET1	336,00

### TOPAC (5 µ)

Bestell-Nr. order no.	Euro
OZ25SETT	408,00



## ZUBEHÖR FÜR WERKZEUGAUFNAHMEN

SPANNSCHLÜSSEL

ÜBERWURFMÜTTERN

ANZUGSBOLZEN

GESTELL FÜR WERKZEUGAUFNAHMEN

HOLZSTECKLEISTE FÜR ER-SPANNZANGEN

ERSATZSCHRAUBEN FÜR WERKZEUGAUFNAHMEN

### accessories for toolholders

spanners

locknuts

pull studs

tool clamping stand

wooden collet stands

spare screws

## ÜBERWURFMUTTERN

locknuts



### ER STANDARD SPANNMUTTER

ER standard locknut

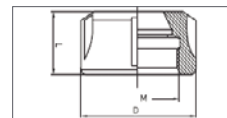

Bestell-Nr. order no.	ER Type	D	L	M	Euro
NER16S	ER 16	32	17.5	M 22 x 1.5	10,40
NER20S	ER 20	35	19	M 25 x 1.5	10,40
NER25S	ER 25	42	20	M 32 x 1.5	11,00
NER32S	ER 32	50	22.5	M 40 x 1.5	11,40
NER40S	ER 40	63	25.5	M 50 x 1.5	15,00
NER50S	ER 50	78	35	M 64 x 2	26,00



### ER SPANNMUTTER - kugelgelagert

ER bearing type locknut

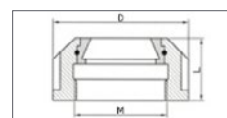

Bestell-Nr. order no.	ER Type	D	L	M	Euro
NER25B	ER 25	42	23	M 32 x 1.5	28,00
NER32B	ER 32	50	25	M 40 x 1.5	28,00
NER40B	ER 40	63	28.5	M 50 x 1.5	30,00



### ER MINI SPANNMUTTER

ER mini locknut

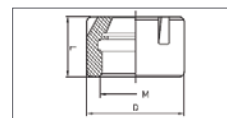

Bestell-Nr. order no.	ER Type	D	L	M	Euro
NER08M	ER 8 MINI	12	11	M 10 x 0.75	11,60
NER11M	ER 11 MINI	16	11.8	M 13 x 0.75	10,40
NER16M	ER 16 MINI	22	19	M 19 x 1	10,40
NER20M	ER 20 MINI	28	19	M 24 x 1	10,60
NER25M	ER 25 MINI	35	20	M 30 x 1	11,20



### ER SECHSKANT SPANNMUTTER

ER hexagon locknut

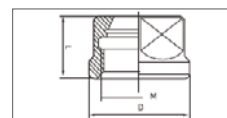

Bestell-Nr. order no.	ER Type	D	L	M	Euro
NER11H	ER 11	19	13.5	M 14 x 0.75	10,40
NER16H	ER 16	28	17	M 22 x 1.5	10,40
NER20H	ER 20	34	19	M 25 x 1.5	10,60



### OZ25 SPANNMUTTER (DIN6388-25)

DIN6388-25 locknut

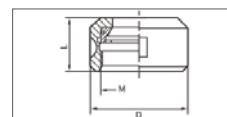

Bestell-Nr. order no.	D	L	M	Euro
NOZ25B	60	33	M48X2	32,00

## SPANNSCHLÜSSEL spanners

### ER STANDARD SPANNSCHLÜSSEL

ER standard spanner

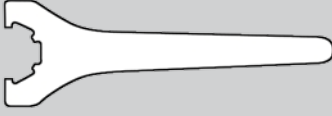
Bestell-Nr. order no.	ER Typ ER type	Euro	
SPER16S	ER 16	8,50	
SPER20S	ER 20	8,60	
SPER25S	ER 25	9,20	
SPER32S	ER 32	10,00	
SPER40S	ER 40	12,60	
SPER50S	ER 50	24,00	

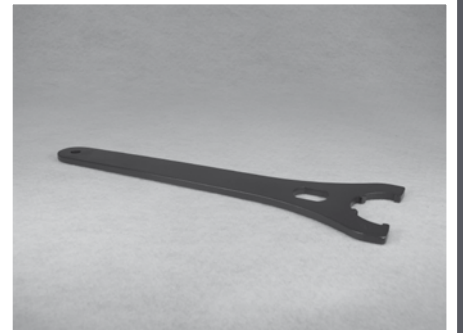

### ER MINI SPANNSCHLÜSSEL

ER mini spanner

Bestell-Nr. order no.	ER Typ ER type	Euro	
SPER08M	ER 8 MINI	10,80	
SPER11M	ER 11 MINI	10,80	
SPER16M	ER 16 MINI	10,80	
SPER20M	ER 20 MINI	12,40	
SPER25M	ER 25 MINI	13,40	

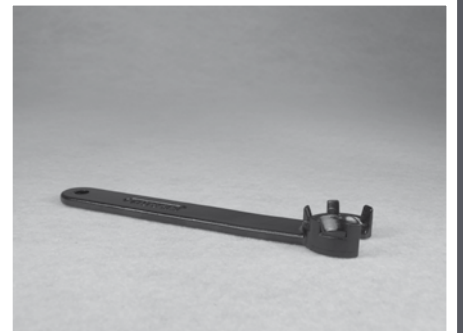

### ER SECHSKANT SPANNSCHLÜSSEL

ER hexagon spanner

Bestell-Nr. order no.	ER Typ ER type	Euro	
SPER11H	ER 11	7,20	
SPER16H	ER 16	7,60	
SPER20H	ER 20	8,00	



### OZ 25 SPANNSCHLÜSSEL DIN6388-25

OZ 25 spanner DIN6388

Bestell-Nr. order no.	ER Typ ER type	Euro	
SPOZ25	DIN6388B-25	10,00	

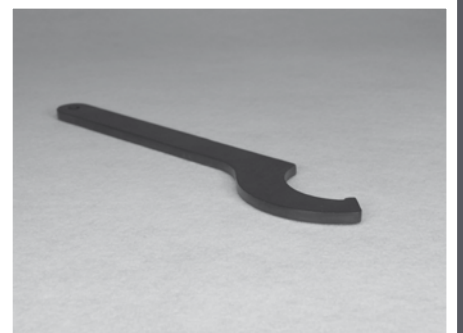

## ANZUGSBOLZEN

pull studs



**TYP MAS 403 BT**

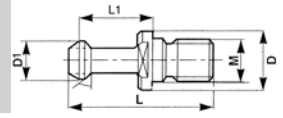

Bestell-Nr.	für Werkzeughalter	M	D	D1	L	L1	$\alpha$	Euro
PSBT3045	BT30	M12	16.5	11	43	23	45°	8,00
PSBT4045	BT40	M16	23	15	60	35	45°	7,20
PSBT4060	BT40	M16	23	15	60	35	60°	7,20
PSBT4090	BT40	M16	23	15	60	35	90°	7,20
PSBT5045	BT50	M24	38	23	85	45	45°	11,00



**TYP MAS 403 BT - INNENKÜHLUNG**

Type MAS 403 BT - internal coolant

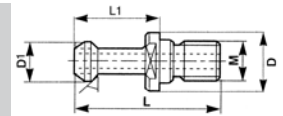

Bestell-Nr.	für Werkzeughalter	M	D	D1	L	L1	$\alpha$	Euro
PSBT4045B	BT40	M16	23	15	60	35	45°	7,80
PSBT5045B	BT50	M24	38	23	85	45	45°	11,80



**TYP DIN 69872A - INNENKÜHLUNG**

Type DIN 69872A - internal coolant

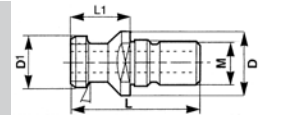

Bestell-Nr.	für Werkzeughalter	M	D	D1	L	L1	$\alpha$	Euro
PS698724A	DIN40 (69871)	M16	23	19	54	26	15°	7,80
PS698725A	DIN50 (69871)	M24	36	28	74	34	15°	11,80



**TYP DIN 69872B**

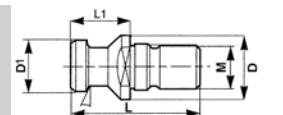

Bestell-Nr.	für Werkzeughalter	M	D	D1	L	L1	$\alpha$	Euro
PS698724B	DIN40 (69871)	M16	23	19	54	26	15°	7,20
PS698725B	DIN50 (69871)	M24	36	28	74	34	15°	11,00



**TYP ISO 7388/2 (1984/B) - INNENKÜHLUNG**

Type ISO 7388/2 (1984/B) - internal coolant

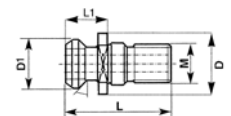

Bestell-Nr.	für Werkzeughalter	M	D	D1	L	L1	$\alpha$	Euro
PS738840A	DIN40 (69871)	M16	22.5	18.9	44.5	16.25	45°	7,80
PS738850A	DIN50 (69871)	M24	36	29.1	65.5	25.55	45°	11,80

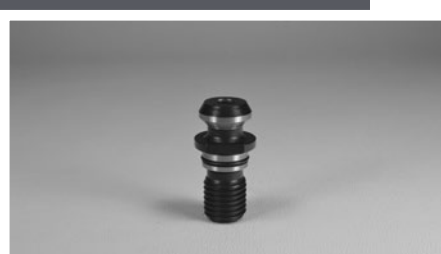

**TYP ISO 7388/2 (1984/B)**

Type ISO 7388/2 (1984/B)

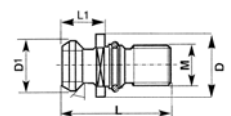

Bestell-Nr.	für Werkzeughalter	M	D	D1	L	L1	$\alpha$	Euro
PS738840B	DIN40 (69871)	M16	22.5	18.9	44.5	16.25	45°	7,20
PS738850B	DIN50 (69871)	M24	36	29.1	65.5	25.55	45°	11,00



## GESTELL FÜR WERKZEUGHALTER

tool clamping stand

Bestell-Nr. order no.	folgende Werkzeughalter können montiert werden suitable tapers	Euro
TBA4050	BT40-BT50 DIN40 - DIN50 (DIN69871) ISO40 - ISO50 (DIN2080)	98,00

Alle genannten Werkzeughalter können im selben Gestell montiert werden.  
Vertikale und horizontale Montage sind im selben Gestell möglich.

All mentioned 40 and 50 toolholders can be mounted in the same stand.  
Vertical and horizontal mounting is available in the same stand.



## HOLZSTECKLEISTEN FÜR ER-SPANNZANGEN

wooden collet stands

Bestell-Nr. order no.	Holzsteckleisten für ER-Spannzangen collets to fit	Euro
WCS08	ER 8	10,00
WCS11	ER 11	10,00
WCS16	ER 16	10,00
WCS20	ER 20	10,00
WCS25	ER 25	13,00
WCS32	ER 32	16,00
WCS40	ER 40	23,00
WCS50	ER 50	23,00
WCSOZ	OZ25 DIN6388-25	23,00



## ERSATZSCHRAUBEN FÜR FRÄSERAUFNAHMEN

face mill adaptor lock screws

Bestell-Nr. order no.	für Werkzeughalter for toolholder	Gewinde size	Euro
SCFM16	FACE MILL Ø16 mm	M8	6,20
SCFM22	FACE MILL Ø22 mm	M10	7,60
SCFM27	FACE MILL Ø27 mm	M12	8,20
SCFM32	FACE MILL Ø32 mm	M16	10,40
SCFM40	FACE MILL Ø40 mm	M20	14,00



## KLEMMSCHRAUBE FÜR WELDON-AUFNAHME

WELDON adaptor side lock screws

Bestell-Nr. order no.	für Werkzeughalter for toolholder	Gewinde size	Euro
SCW06	WELDON Ø6 mm	M6X10	2,40
SCW08	WELDON Ø8 mm	M8X10	2,40
SCW10	WELDON Ø10 mm	M10X12	3,50
SCW12	WELDON Ø12 mm	M12X16	3,50
SCW14	WELDON Ø14 mm	M12X16	3,50
SCW16	WELDON Ø16 mm	M14X16	3,70
SCW20	WELDON Ø20 mm	M16X20	4,00
SCW25	WELDON Ø25 mm	M18X2X20	6,60
SCW32	WELDON Ø32 mm	M20X2X20	7,00
SCW40	WELDON Ø40 mm	M20X2X25	7,20



## DRUCKSPANNZANGEN DIN6343

workholding collets DIN6343

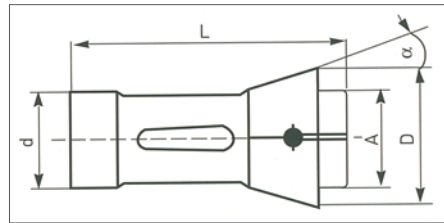

Bestell-Nr. order no.	Typ type	d	L	D	A	$\alpha$	Euro		
							● rund ● round	⬡ 6-kant ⬡ hexagon	■ 4-kant ■ square
FC140E	140E	22	55	30	21	15°	<b>21,00</b> (3-16 mm)	<b>34,00</b> (5-13 mm)	<b>38,00</b> (5-10 mm)
FC148E	148E	28	70	38	28	15°	<b>25,00</b> (3-22 mm)	<b>38,00</b> (5-19 mm)	<b>42,00</b> (5-15 mm)
FC161E	161E	32	75	45	34	15°	<b>27,00</b> (3-26 mm)	<b>40,00</b> (5-22 mm)	<b>44,00</b> (5-18 mm)
FC162E	162E	35	70	43	34	15°	<b>29,00</b> (3-25 mm)	<b>42,00</b> (5-22 mm)	<b>46,00</b> (5-18 mm)
FC163E	163E	35	80	48	38	15°	<b>28,00</b> (3-30 mm)	<b>40,00</b> (5-26 mm)	<b>44,00</b> (5-20 mm)
FC171E	171E	42	94	55	42	15°	<b>39,00</b> (3-36 mm)	<b>49,00</b> (5-30 mm)	<b>49,00</b> (5-25 mm)
FC173E	173E	48	94	60	50	15°	<b>39,00</b> (3-42 mm)	<b>49,00</b> (5-36 mm)	<b>49,00</b> (5-29 mm)
FC185E	185E	66	110	84	73	15°	<b>69,00</b> (4-60 mm)	<b>89,00</b> (10-52 mm)	<b>89,00</b> (7-42 mm)





Robert-Bosch-Str. 2  
75233 Tiefenbronn

Telefon: +49 7234 94592-0  
Telefax: +49 7234 94592-29

E-Mail: [info@stalex.de](mailto:info@stalex.de)  
Web: [www.stalex.de](http://www.stalex.de)

**Alle Preisangaben in Euro zzgl. gesetzlicher Mehrwertsteuer. Druckfehler, Irrtümer und Änderungen vorbehalten.  
Nur solange der Vorrat reicht.**

All prices published are in EURO (€) and exclude sales tax. Errors and omissions excepted.  
Prices may be subject to change without prior notice. All items are subject to availability.